

CROPLANDS

COMPACT SPRAYERS



BUYERS GUIDE • JANUARY 2024

CROPLANDS.COM.AU

CROPLANDS IS COMMITTED TO A SUSTAINABLE FUTURE



For the last 50 years, Croplands has been proudly helping Australian farmers eliminate weeds. With an unwavering commitment to produce spraying equipment that is efficient, reliable and engineered to endure, Croplands is always seeking to save you time, reduce your costs and maximise your productivity.



FSC
Logo

S U P P L Y I N G T H E I N D U S T R Y ' S B E S T

ALBUZ

 **agrotop**

Est. 1958
MODENA, ITALY



BANJ 

POWERED by
HONDA

 **PENTAIR**

 **QUIK CORP**



SWISSMEX

 **Spraying Systems Co.**



COMPACT SPRAYERS

SPRAYING EQUIPMENT & ACCESSORIES

4	LINKAGE
14	BOOMS
17	BOOM ACCESSORIES
18	CROPAIR
20	TRAILPAK
24	RETRASPRAY
25	TRAYPAK
28	CROPPAK
30	KNAPSACKS
32	CROPPAK & SWISSMEX ACCESSORIES
34	REELS & PRESSURE GAUGE ACCESSORIES
35	SPRAY GUNS & LANCES
36	CHEMICAL MIXING & TRANSFER

SAFETY EQUIPMENT

39	SAFETY PROTECTIVE EQUIPMENT
----	-----------------------------

FIREFIGHTERS

40	FIREFIGHTERS FIRE SAFETY RANGE
----	--------------------------------

SPRAY TANKS

41	SPRAY TANKS
----	-------------

PUMPS

43	AR – LOW PRESSURE PUMPS
44	AR – MEDIUM & HIGH PRESSURE PUMPS
45	AR – MOTORISED PUMPS
46	AR PARTS & ACCESSORIES
47	MANUAL CONTROL VALVES & REGULATORS
48	HYPRO – CENTRIFUGAL PUMPS
49	HYPRO – TRANSFER PUMPS
50	SHURFLO PUMPS & ACCESSORIES
51	FLOJET PUMPS & ACCESSORIES

CONTROLLERS, VALVES & ELECTRICS

52	ELECTRIC CONTROL KITS
53	AUTO RATE CONTROLLERS
54	MANIFOLDS, SWITCHBOXES & COMPONENTS
55	VALVE KITS ELECTRIC & MANUAL
56	GPS SYSTEMS
57	SPRAYING TOOLS & COVERAGE

NOZZLES & CAPS

59	SPRAYWISE
60	CEREAL SEGMENT GUIDE
62	NOZZLE FLOW CHART
64	SPRAY QUALITY CHARTS
66	AGROTOP – NOZZLE SELECTION
67	ALBUZ – NOZZLE SELECTION
68	HYPRO – NOZZLE SELECTION
69	TEEJET – NOZZLE SELECTION
70	NOZZLE CAPS
71	NOZZLE BODIES & FILTERS
72	SPRAY NOZZLES WIDE ANGLE FLAT & FERTILISER
73	SPRAY NOZZLES SPECIALISED APPLICATION
74	HORTICULTURE - NOZZLE SELECTION
77	TURBODROP® NOZZLES NARROW ANGLE AI
78	BODIES & CAPS FOR HORTICULTURE
79	DISCS & CORES
80	TERMS & CONDITIONS OF SALE
82	FREIGHT



THIS GUIDE IS PRINTED ON CARBON NEUTRAL PAPER.
FINSBURY GREEN PRINTED CARBON NEUTRAL.

LINKAGE SPRAYERS



Croplands linkage sprayers are engineered to deliver safe and efficient spray application. Hard-wearing and long-lasting UV-stabilised tanks range in capacity from 300 up to 1600 litres, offering spraying solutions for properties of all sizes.



Market leading pump capacity

Fitted with Annovi Reverberi triple-diaphragm positive-displacement pumps, Croplands linkage units deliver optimal flow and pressure



Control and coverage

Fitted standard to Croplands linkage booms, Agrotop AirMix air-induction nozzles are designed to provide optimal drift control and surface coverage

LINKAGE

AGRIPAK 300

SCAN FOR
VIDEO



300L AGRIPAK LINKAGE
WITH THE OPTIONAL 4M BOOM

OPTIONS SEE PAGES 12-13

KEY FEATURES

1. 5-tap control with master on/off lever
2. Isometric gauge for accuracy
3. 10L handwash tank
4. 40L flushing tank
5. Main tank drain
6. Protected nozzles
7. Stainless-steel boom lines
8. Spring-loaded boom breakaways
9. Galvanised boom and frame
10. Easily accessible and protected filter
11. Protected pump supplied with PTO shaft
12. Venturi tank agitation
13. Easy-adjust boom height slides



300L AGRIPAK LINKAGE
WITH BOOM

AGRIPAK 300

WIDTH: 1200MM LENGTH: 900MM HEIGHT: 1420MM WEIGHT: 160KG

		\$ (EX. GST)	\$ (INC. GST)	PROD. CAT.
LA300	300L AgriPak linkage sprayer with flush tank. Fitted with AR80 liquid-fertiliser-ready pump, UCM 5-way controller fitted (no hose reel or boom – see options)	4,048.00	4,452.80	A
LA300/MBX04	- 4m MBX series boom fitted	5,490.00	6,039.00	A
LA300/MBX06	- 6m MBX series boom fitted	5,734.00	6,307.40	A
LA300/MSCL-2	- double-sided covered boom fitted	5,960.00	6,556.00	A
LA300/XTKIT	- XT boom kit fitted with X Tender boom jets. Standard X Tender nozzles fitted are #24, which gives coverage of up to 8m width depending on height the XT boom kit is mounted. An ideal choice for hill country or liquid-fertiliser applications	4,908.00	5,398.80	A

Disclaimer: dimensional and weight information supplied is for base model only with no options. This information is subject to change without notice.

LINKAGE

AGRIPAK 600

SCAN FOR
VIDEO



600L AGRIPAK LINKAGE WITH OPTIONAL BOOM,
HOSE REEL, ELECTRIC CONTROLS AND FOAM MARKER

OPTIONS SEE PAGES 12-13

KEY FEATURES

1. 5-tap control with master on/off lever
2. Isometric gauge for accuracy
3. 15L handwash tank
4. 80L flushing tank
5. Main tank drain
6. Protected nozzles
7. Stainless-steel boom lines
8. Spring-loaded boom breakaways
9. Galvanised boom and frame
10. 3-way tap by filter to allow tank selection
11. Rear-mounted AR triple-diaphragm pump supplied with PTO shaft
12. Venturi tank agitation
13. Easy-adjust boom height slides



600 AGRIPAK LINKAGE
WITH BOOM

AGRIPAK 600

WIDTH: 1400MM LENGTH: 1100MM HEIGHT: 1600MM WEIGHT: 200KG

		\$ (EX. GST)	\$ (INC. GST)	PROD. CAT.
LA600	600L AgriPak linkage sprayer with flushing tank, handwash tank, AR80 liquid-fertiliser-ready pump, UCM 5-way controller (no hose reel or boom – see options)	4,557.00	5,012.70	A
LA600/MBX06	- 6m MBX series boom fitted	6,302.00	6,932.20	A
LA600/MAX08	- 8m MAX series boom fitted – no self-leveller	7,578.00	8,335.80	A
LA600/MAX08L	- 8m MAX series boom fitted – and self-leveller	8,384.00	9,222.40	A
LA600/MAX10	- 10m MAX series boom fitted – no self-leveller	8,364.00	9,200.40	A

Disclaimer: dimensional and weight information supplied is for base model only with no options. This information is subject to change without notice.

LINKAGE

AGRIPAK 800

SCAN FOR
VIDEO



800L AGRIPAK LINKAGE WITH
THE OPTIONAL 8M BOOM

OPTIONS SEE PAGES 12-13

KEY FEATURES

1. 5-tap control with master on/off lever
2. Isometric gauge for accuracy
3. 15L handwash tank
4. 80L flushing tank for in-field clean out
5. Main tank drain for complete clean out
6. Protected nozzles
7. Stainless-steel boom lines
8. Spring-loaded boom breakaways
9. Galvanised boom and frame
10. Easily accessible and protected filter
11. Rear-mounted AR triple-diaphragm pump supplied with PTO shaft
12. Venturi tank agitation
13. Easy-adjust boom height slides
14. Optional slide-out rear park legs



800L AGRIPAK LINKAGE
WITH THE OPTIONAL
8M BOOM

AGRIPAK 800

WIDTH: 1400MM LENGTH: 1000MM HEIGHT: 1700MM WEIGHT: 200KG

		\$ (EX. GST)	\$ (INC. GST)	PROD. CAT.
LA800	800L AgriPak linkage sprayer with flushing tank, handwash tank, AR80 liquid-fertiliser-ready pump, UCM 5-way controller (no hose reel or boom – see options)	5,105.00	5,615.50	A
LA800/MAX08	- 8m MAX series boom fitted – no self-leveller	8,156.00	8,971.60	A
LA800/MAX08L	- 8m MAX series boom fitted – and self-leveller	8,965.00	9,861.50	A
LA800/MAX10	- 10m MAX series boom fitted – no self-leveller	8,877.00	9,764.70	A
LA800/MAX10L	- 10m MAX series boom fitted – and self-leveller	9,679.00	10,646.90	A

Disclaimer: dimensional and weight information supplied is for base model only with no options. This information is subject to change without notice.

LINKAGE

AGRIPAK 1000

LAC1000 AGRIPAK LINKAGE WITH
10M MANUAL-FOLD BOOM



SCAN FOR
VIDEO



KEY FEATURES

1. 5-tap control with master on/off lever (not pictured)
2. Isometric gauge for accuracy (not pictured)
3. 15L handwash tank
4. 100L flushing tank for in-field clean out
5. Main tank drain for complete clean out
6. Protected nozzles
7. Stainless-steel boom lines
8. Spring-loaded boom breakaways



9. Galvanised boom and frame
10. Easily accessible and protected filter
11. Rear-mounted AR triple-diaphragm pump
12. Venturi tank agitation
13. Easy-adjust boom height slides
14. Slide-out rear park legs and forklift points for safe loading/unloading
15. Fold-up step standard
16. Over-top support for added strength



OPTIONS SEE PAGES 12-13

AGRIPAK 1000

WIDTH: 1420MM LENGTH: 1100MM HEIGHT: 1800MM WEIGHT: 450KG

		\$ (EX. GST)	\$ (INC. GST)	PROD. CAT.
LAC1000	1000L AgriPak linkage sprayer with flush tank. Fitted with AR80 pump, UCM 5-way controller (base model, no hose reel or boom). Venturi agitation fitted standard	7,359.00	8,094.90	A
LAC1000/8M	- 8m MAX manual-fold boom – 3 sections	10,456.00	11,501.60	A
LAC1000/8ML	- 8m MAX manual-fold boom with self-leveller fitted – 3 sections	11,245.00	12,369.50	A
LAC1000/10M	- 10m MAX manual-fold boom – 3 sections	11,250.00	12,375.00	A
LAC1000/10ML	- 10m MAX manual-fold boom with self-leveller fitted – 3 sections	11,862.00	13,048.20	A
LAC1000/12ML	- 12m MAX manual-fold boom with self-leveller fitted – 3 sections	12,742.00	14,016.20	A
LAC1000/MHL12	- 12m hydraulic-fold boom with self-leveller – 3 sections	21,218.00	23,339.80	A
LAC1000/MHL15	- 15m hydraulic-fold boom with self-leveller – 3 sections	22,592.00	24,851.20	A

Disclaimer: dimensional and weight information supplied is for base model only with no options. This information is subject to change without notice.

LINKAGE

AGRIPAK PRO 1300 & 1600



KEY FEATURES

1. Calibrated and UV-stabilised poly tank with sight tube and litres marked
2. Integrated handwash tank
3. 170L flushing tank for in-field clean out
4. 30L chemical mixer/induction unit standard
5. Easy-access drain system for quick draining and clean out
6. Protected large suction filter with shut-off valve for easy cleaning
7. Large filling lid with strainer
8. Nozzles are protected on all booms to avoid damage
9. Stainless-steel boom tubing with non-drip nozzle bodies
10. Integrated 1,000mm hydraulic lift device
11. 160 L/min AR triple-diaphragm pump mounted beneath the tank for excellent suction and safety
12. Dual venturi and bypass agitation
13. Stabiliser legs fitted to the frame to keep unit safe from tipping when parked
14. Forklift points on bottom frame rails to assist with loading/unloading from a vehicle
15. Folding access step for safety
16. Clothing and glove locker

OPTIONS SEE PAGES 12-13

AGRIPAK 1300 & 1600 - BASE MODELS (NO BOOM)

1300: WIDTH: 2000MM LENGTH: 950MM HEIGHT: 2050MM WEIGHT: 400KG
 1600: WIDTH: 2020MM LENGTH: 1050MM HEIGHT: 2150MM WEIGHT: 450KG

		\$ (EX. GST)	\$ (INC. GST)	PROD. CAT.
LM13/160	1300L linkage base unit with AR160 PTO-drive diaphragm pump. In-cab electric 3-section control unit, flushing and handwash tank. 1,000mm integrated hydraulic height adjuster. 30L chemical mixer fitted. Choose a boom option from page 12, or for standard hydraulic-fold 12 and 15m booms, see below	23,415.00	25,756.50	D
LM16/160	- 1600L linkage base unit	24,570.00	27,027.00	D
LM13/MHL12	1300L linkage base unit with AR160 PTO-drive diaphragm pump. In-cab electric 3-section control unit, flushing and handwash tank. 1,000mm integrated hydraulic height adjuster. 30L chemical mixer fitted. 12m hydraulic-fold MHL boom fitted with individual left/right fold	36,225.00	39,847.50	D
LM13/MHL15	- 1300L linkage base unit and 15m hydraulic-fold MHL boom fitted	37,959.00	41,754.90	D
LM16/MHL12	- 1600L linkage base unit and 12m hydraulic-fold MHL boom fitted	37,373.00	41,110.30	D
LM16/MHL15	- 1600L linkage base unit and 15m hydraulic-fold MHL boom fitted	39,085.00	42,993.50	D

LINKAGE

AGRIPAK SPECIAL 1300 & 1600



AGRIPAK SPECIAL 1300

		\$ (EX. GST)	\$ (INC. GST)	PROD. CAT.
LS1300/160	1300L linkage base unit with heavy duty galvanized frame, fitted with AR160 PTO-drive pump, In-cab electric 3 section control, flush tank and handwash tank. 1,500mm integrated hydraulic height adjuster. 30L chemical mixer fitted. Choose a boom spec'd option below, ranging from 16m-21m fully hydraulic side folding. Booms specific to this linkage option only.	30,280.00	33,308.00	D
LS1300/16STD	1300L linkage base unit and 16m standard hydraulic boom fitted	54,592.00	60,051.20	D
LS1300/16GV	1300L linkage base unit with 16m hydraulic fold boom with hydraulic wing lift fitted	60,574.00	66,631.40	D
LS1300/18STD	1300L linkage base unit and 18m standard hydraulic boom fitted	54,973.00	60,470.30	D
LS1300/18GV	1300L linkage base unit with 18m hydraulic fold boom with hydraulic wing lift fitted	61,408.00	67,548.80	D
LS1300/21STD	1300L linkage base unit and 21m standard hydraulic boom fitted	55,354.00	60,889.40	D
LS1300/21GV	1300L linkage base unit with 21m hydraulic fold boom with hydraulic wing lift fitted	62,242.00	68,466.20	D

AGRIPAK SPECIAL 1600

		\$ (EX. GST)	\$ (INC. GST)	PROD. CAT.
LS1600/160	1600L linkage base unit with heavy duty galvanized frame, fitted with AR160 PTO-drive pump, In-cab electric 3 section control, flush tank and handwash tank. 1,500mm integrated hydraulic height adjuster. 30L chemical mixer fitted. Choose a boom spec'd option below, ranging from 16m-21m fully hydraulic side folding. Booms specific to this linkage option only.	30,748.00	33,822.80	D
LS1600/16STD	1600L linkage base unit and 16m standard hydraulic boom fitted	55,060.00	60,566.00	D
LS1600/16GV	1600L linkage base unit with 16m hydraulic fold boom with hydraulic wing lift fitted	61,042.00	67,146.20	D
LS1600/18STD	1600L linkage base unit and 18m standard hydraulic boom fitted	55,441.00	60,985.10	D
LS1600/18GV	1600L linkage base unit with 18m hydraulic fold boom with hydraulic wing lift fitted	61,876.00	68,063.60	D
LS1600/21STD	1600L linkage base unit and 21m standard hydraulic boom fitted	55,822.00	61,404.20	D
LS1600/21GV	1600L linkage base unit with 21m hydraulic fold boom with hydraulic wing lift fitted	62,710.00	68,981.00	D

OPTIONS



LR2412

HOSE REELS

			\$ (EX. GST)	\$ (INC. GST)
Page 34	All models	L-R2412	Heavy-duty steel hose reel with 30m hose and Turbo400 gun	967.00 1,063.70
	All models	L-R3000	Manual spring-loaded retractable reel, 15m hose and spray lance	421.00 463.10



MAX08

BOOMS

Page 16	300, 600, 800, 1000	MSCL-2	Adjustable width covered boom	2,028.00	2,230.80
	300, 600	MBX04	4m MBX series manual cross-fold boom	1,425.00	1,567.50
	300, 600	MBX06	6m MBX series manual cross-fold boom	1,748.00	1,922.80
Page 14	300, 600, 800, 1000	MAX08	8m MAX series manual cross-fold boom	3,198.00	3,517.80
	300, 600, 800, 1000	MAX08L	8m MAX series manual cross-fold boom with self-levelling device	4,122.00	4,534.20
	600, 800, 1000	MAX10	10m MAX series manual cross-fold boom	3,995.00	4,394.50
	600, 800, 1000	MAX10L	10m MAX series manual cross-fold boom with self-levelling device	5,024.00	5,526.40
	600, 800, 1000, 1300, 1600	MAX12L	12m MAX series manual cross-fold boom with self-levelling device	5,706.00	6,276.60
	300, 600, 800, 1000	GEX06H	6m GEX series hydraulic cross-fold boom	7,397.00	8,136.70
	600, 800, 1000	GEX08H	8m GEX series hydraulic cross-fold boom	8,357.00	9,192.70
Page 15	600, 800, 1000, 1300, 1600	GEX10H	10m GEX series hydraulic cross-fold boom	9,078.00	9,985.80
	1000, 1300, 1600	MHL12	12m Hydralink series hydraulic cross-fold boom with self-levelling device	13,549.00	14,903.90
	1000, 1300, 1600	MHL15	15m Hydralink series hydraulic cross-fold boom with self-levelling device	15,275.00	16,802.50



A4065845CW



BTEF-SELETRON



A466852043



XTBOOMKIT

BOOM EXTRAS

Page 15	1000, 1300, 1600	MHL12-2-KIT	Second set of hydraulic hoses to allow individual left and right fold of MHL boom (note – ensure your tractor has sufficient hydraulic remotes)	695.00	764.50
	All models	GEX-2-KIT	Second set of hydraulic hoses to allow individual left and right fold of GEX boom (note – ensure your tractor has sufficient hydraulic remotes)	695.00	764.50
N/A	All models	A4065845CW	Adjustable boom-end nozzle with manual tap for fence-line spraying. (Not for use with MSCL-2)	66.00	72.60
	All models	BTEF-SELETRONRH	Electric fence-line kit to clamp around boom tube – right-hand side. Must have electric or auto-rate control fitted for this option	363.00	399.30
N/A	All models	BTEF-SELETRONLH	Electric fence-line kit to clamp around boom tube – left-hand side. Must have electric or auto-rate control fitted for this option	363.00	399.30
	All models	A466852043	Switchbox for Seletron fence-line kit	334.00	367.40
Page 17	300, 600, 800, 1000	XTBOOMKIT	Kit to mount Croplands XT boomless nozzle kit to your sprayer. Kit includes 2 x #10 XT nozzles on adjustable-swivel nozzle bodies, steel bracket and 2 x clamps for mounting. Hose and fittings to your pump are not supplied	554.00	609.40
N/A	600, 800, 1000, 1300, 1600	5880-KIT	Brass 5880-3/4-2TOC20 BoomJet for high-volume applications (other sizes available, talk to Croplands)	1,105.00	1,215.50
Page 15	MHL/MAX Booms only	BT-TRIPLEX	BT-TRIPLEX Triple nozzle bodies c/w Airmix jets #02, 025, 03 & caps fitted	80.00	88.00

HYDRAULIC BOOM LIFT DEVICES

\$ (EX. GST) \$ (INC. GST)

N/A	600, 800	LP060-LIFT	1000mm hydraulic boom-lift with hydraulic hose kit to tractor (requires 1 set hyd tractor remotes)	3,671.00	4,038.10
	1000, 1300, 1600	LT-FMHYDADJUST2	1500mm hydraulic boom-lift with hydraulic hose kit to tractor, this lift must be selected when fitting an MHL Boom to any Agripak	6,975.00	7,672.50



GB383899000V

BOOM SUSPENSION OPTION

N/A	1000, 1300, 1600	GB383899000V	Airbag parallelogram suspension device to protect booms – ideal if a boom-lift device is not fitted or a nitrogen accumulator is not practical	3,587.00	3,945.70
	1000, 1300, 1600	BP-704-7	Hydraulic accumulator suspension kit for strictly MHL booms. If accumulator is selected, the 1500mm lift kit above must also be selected	2,116.00	2,327.60



LH9351A



HT-PROBE

CHEMICAL MIXING, INDUCTION HOPPER AND QUICK FILL

Page 37	300, 600, 800, 1000	A5033301	35L chemical mixing and induction hopper fitted at fixed height at the side of the linkage sprayer. Fully enclosed for safe mixing, with container rinse function	2,344.00	2,578.40
	600, 800, 1000	L-H9351A	60L chemical mixing and induction hopper fitted at fixed height at the side of the linkage sprayer. Fully enclosed for safe mixing, with container rinse function	2,344.00	2,578.40
N/A	All models	HT-QF2	1½" quick fill with camlock fitted. Mounted in the top of the tank	225.00	247.50
N/A	600, 800, 1000	HT-PROBE	Optional suction probe fitted	768.00	844.80



AR140LFP-C

PUMP AND PUMP DRIVE UPGRADE

Page 43	600, 800, 1000	AR140LFP-C	AR140LFP liquid-fertiliser-ready pump in lieu of standard 80L pump. (133 L/min rated at 0-pressure, 0–15 bar)	767.00	843.70
---------	----------------	-------------------	---	--------	--------

ELECTRIC AND AUTO-SPRAY RATE CONTROL OPTIONS

Page 53	300, 600, 800, 1000	LT-FMI-E2012	ARAG single-switch electric control kit fitted for boom shut-off using in-cab switchbox (boom-section control is manually done using taps)	134.00	147.40
	300, 600, 800, 1000	LT-FMIE2032A	ARAG 3-section electric control kit for individual on/off of 3 boom sections. Includes master on/off and electric pressure adjustment from in-cab switchbox	1,827.00	2,009.70
		LT-FMI-E2032	Geoline option of above electric control kit	1,474.00	1,621.40
Page 53	All models	LT-FMIE2052A	ARAG electric in-cab controller with switchbox. 5-section electric valves for individual section shut off, electric pressure regulating valve and a master on/off can all be operated from the switchbox in the cab or vehicle. Requires a reliable 12V power supply	2,564.00	2,820.40
		LT-FMI-E2052	Geoline option of above electric control kit	1,953.00	2,148.30
	All models	LT-FMBA5000GEO3	Croplands 3-section fully auto spray-rate control of spraying application. Dual-screen display, 3 boom-section control, auto spray-rate adjustment	5,861.00	6,447.10
	All models	LT-FMBRAVO3SEC	Bravo180 3-section fully auto spray-rate control of spraying application. Dual-screen display, 3 boom-section control, auto spray-rate adjustment	6,843.00	7,527.30
		LT-FMISOBUSARAG	ARAG IBX ISOBUS interface (no console supplied with this option)	7,339.00	8,072.90
		LT-FMTRIMFIQ3	Trimble-ready option, field IQ module included, no console included	9,310.00	10,241.00
		BT-ARAG5	5-section ARAG valves	1,214.00	1,335.40



BA5000-GEO5



BRAVO180-ARAG5

GUIDANCE AND FOAM MARKERS

Page 17	All models	A5200052	Double-sided foam marker with in-cab left/right control	2,619.00	2,880.90
Page 56	All models	TOPXD-01	Topcon Manual Guidance with receiver and XD Console	4,760.00	5,236.00
	All models	GD430-GLO-P-L	Matrix 430 GPS mapping system complete with patch antenna (antenna upgrade available, see page 54)	4,914.00	5,405.40



TOPXD-01

BOOMS

MANUAL

Made of steel to deliver long-lasting quality, Croplands manual-fold booms feature stainless-steel boom tubing with non-drip nozzle bodies and Agrotop AirMix low-drift nozzles.

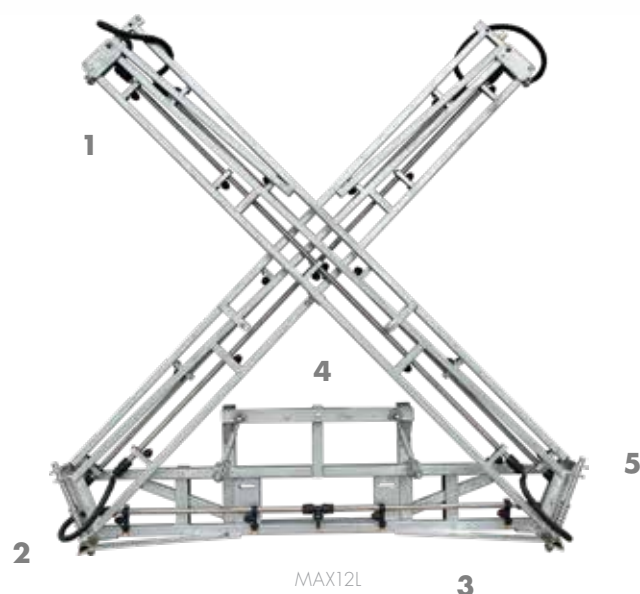

KEY FEATURES

MBX

1. Galvanised steel construction
2. Tension spring breakaway for each boom arm
3. Folds neatly behind sprayer/vehicle (with the exception of MB02, which is a fixed boom)

MAX

1. Hot-dipped galvanised finish
2. Self-returning breakaway on boom arms
3. Can be plumbed in 3 to 5 sections
4. Self-levelling device standard on 12m boom, optional on 8 and 10m booms. Self-leveller can be locked if required
5. Detach hose with ease

MANUAL-FOLD BOOMS

		\$ (EX. GST)	\$ (INC. GST)	PROD. CAT.
MB02	One-piece 2m boom with 4 non-drip nozzles at 500mm spacings	438.00	481.80	A
MBX04	4m galvanised boom; 8 non-drip nozzles at 500mm spacings. 1.2m folded width. Ideal for RTVs, small sprayers and utes	1,370.00	1,507.00	A
MBX06	6m galvanised boom; 12 non-drip nozzles at 500mm spacing. Suitable for linkage sprayers, vehicles and traymount sprayers	1,680.00	1,848.00	A
MAX08	8m MAX series cross-fold boom, without self-leveller	3,075.00	3,382.50	A
MAX08L	- with self-leveller	3,963.00	4,359.30	A
MAX10	10m MAX series cross-fold boom, without self-leveller	3,841.00	4,225.10	A
MAX10L	- with self-leveller	4,830.00	5,313.00	A
MAX12L	12m MAX series boom with self-leveller (not available without self-leveller)	5,486.00	6,034.60	A

BOOMS

HYDRAULIC

Ideal for small row cropping, vegetables or undulating farm country, Croplands hydraulic boom options feature heavy-duty galvanised steel construction and stainless-steel boom tubes.

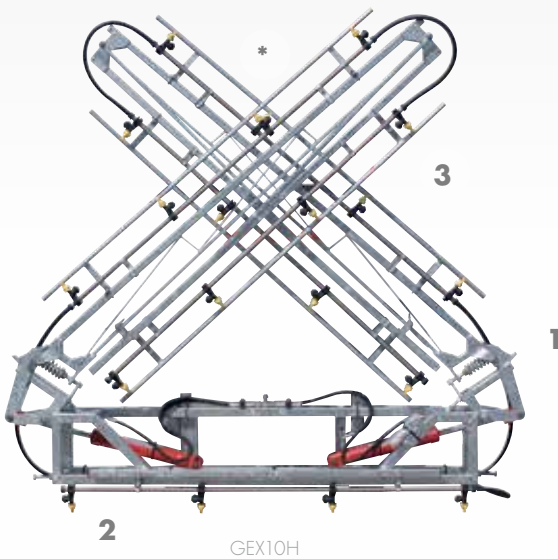

GEX10H

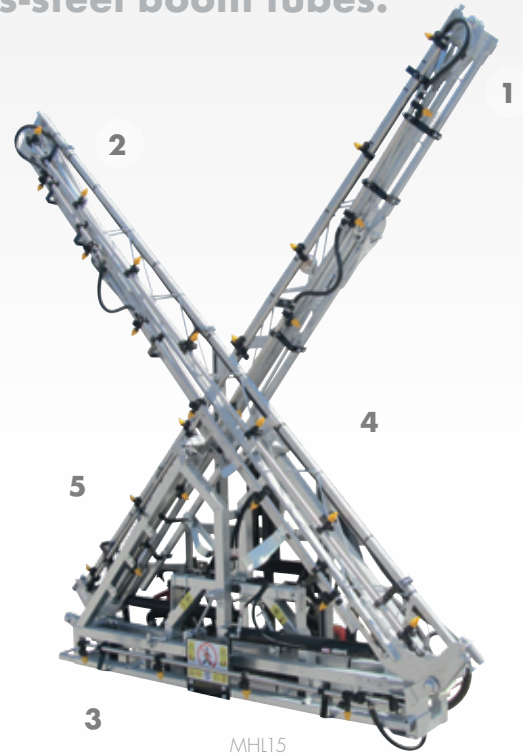

MHL15

KEY FEATURES

GEX

1. Tension breakaway for each boom arm
2. Boom folds hydraulically in cross-fold
3. 8 and 10m models have a flip-over outer section, which needs to be manually secured in the folded position prior to folding the boom for transport

*Protection rails no longer included or available.

HYDRALINK

1. Nozzles and nozzle bodies mounted behind boom
2. Tension breakaway on outer sections
3. Self-levelling centre section standard
4. Boom folds sequentially in cross-fold for transport
5. Using left/right hydraulic kit option, each side can be lifted independently, which also automatically locks the self-levelling system

HYDRAULIC-FOLD BOOMS

		\$ (EX. GST)	\$ (INC. GST)	PROD. CAT.
GEX06H	6m galvanised hydraulic-folding boom; 12 non-drip nozzle bodies, two rams for folding, hydraulically plumbed to fold together. Weight = 87kg	7,112.00	7,823.20	A
GEX08H	8m galvanised half-hydraulic-folding boom; 16 non-drip nozzle bodies, two rams for folding, hydraulically plumbed to fold together. 1m of each end is manually unfolded to make the boom 8m. Weight = 93kg	8,035.00	8,838.50	A
GEX10H	10m galvanised half-hydraulic-folding boom; 20 non-drip nozzle bodies, two rams for folding, hydraulically plumbed to fold together. 2m of each end is manually unfolded to make the boom 10m. Weight = 96kg	8,728.00	9,600.80	A
GEX-2-KIT	Second set of hydraulic hoses to allow left/right individual fold of GEX boom (text on your order)	670.00	737.00	A
MHL12	Heavy-duty galvanised 12m full hydraulic-folding boom with 24 nozzles, twin ram with auto-folding tips, hydraulically plumbed to fold both sides together. Central self-locking self-leveller standard	13,027.00	14,329.70	A
MHL15	- with heavy-duty galvanised 15m hydraulic-folding boom with 30 nozzles	14,687.00	16,155.70	A
MHL12-2-KIT	Second set of hydraulic hoses to allow left/right individual fold of MHL boom (text on your order)	670.00	737.00	A

BOOMS

FIREBREAK, UNDER TREE & COVERED



MVB5-5



MC6 FIREBREAK BOOM
SHOWN FITTED TO TRAY

VERTIBOOM

1. Ideal for small horticultural growers
2. Vertical spray application, 5 nozzles per side



MSCL-2 SHOWN NARROW



MSCL-2 SHOWN WIDE

SHROUDED BOOM

1. For spraying under sensitive crops such as grapes or trellis tomatoes
2. Single or double-sided options

FIREBREAK BOOM

1. For spraying firebreaks, farm tracks, contours, ditches and fence-lines
2. 1.5m wide with offset nozzles on adjustable-swivel nozzle bodies on each end for additional 1.5m spray each side
3. Ideal for the back of utes or small trailing sprayers



MSO

UNDER-TREE BOOM

1. Perfect for spraying under trees or hedgerows
2. Galvanised boom with breakaway
3. Extendable outer section with two nozzles can be lifted up for transport

			\$ (EX. GST)	\$ (INC. GST)	PROD. CAT.
MVB5-5	Vertiboom	5 nozzles per side Vertiboom. Ideal for small horticultural growers	1,214.00	1,335.40	B
MC6	Firebreak boom	1.5m wide Firebreak boom	822.00	904.20	A
MSCL	Shrouded boom	Single-sided light-covered boom with breakaway and 2 nozzles under spray shield	699.00	768.90	A
MSCL-2		Double-sided light-covered boom with left/right shielded booms with breakaways, adjustable width, and a 600mm wide uncovered centre section with 2 nozzles	1,950.00	2,145.00	A
MSO	Under-tree boom	Treeline boom with breakaway and 2 nozzles	845.00	929.50	A

BOOM ACCESSORIES

KEY FEATURES

XT BOOM

1. Target areas not easily accessed by a conventional boom with the Croplands XT Boomless Nozzle kit
2. The XT Boom kit delivers a uniform spray pattern over a distance of up to 6.5m
3. Fitted standard with #10 nozzles, see below chart for more application details



XT BOOM KIT IN ACTION

BOOM KITS

											\$ (EX. GST)	\$ (INC. GST)	PROD. CAT.
XTBOOMKIT	Kit to mount Croplands XT boomless nozzle kit to your sprayer. Kit includes 2 x #10 XT nozzles on adjustable-swivel nozzle bodies, steel bracket and 2 x clamps for mounting. Hose and fittings to your pump are not supplied										532.00	585.20	B
XTNOZZLEKIT	XT boomless nozzle kit, includes 2 x #10 XT nozzles on adjustable-swivel nozzle bodies, no bracket, clamps or hoses supplied										449.00	493.90	B
	Nozzle size	Pressure (bar)	Flow (L/min) 2 nozzles	Application rate L/Ha – at swath width shown km/hr						Approximate swath width at 90cm height (XT 2-nozzle kit)			
				4 km/hr	5 km/hr	6 km/hr	7 km/hr	8 km/hr	10 km/hr			12 km/hr	
	10	2	6.4	166	132	110	95	83	66	55	5.8		
		3	7.8	202	161	134	115	101	81	67	6.5		



*Disclaimer: all values are calculated application rates in L/ha based on the swath width in the far right column and assuming the pressure and flow can be achieved using the pump on your sprayer. 90cm height from the spray target is recommended using Croplands UA300B trailed sprayers but may vary depending on the sprayer being fitted to, the available mounting height, and the vehicle the XT kit is being fitted to. If the height is adjusted upwards the application rate will be lower; if the kit is adjusted to spray wider than the table suggests, the application rate will be lower. The reverse will be true if the height and/or width is reduced. Larger nozzle sizes are available on request. Ensure your pump has adequate flow to achieve the desired spray rate and sprayed width. For more information visit hypro.pentair.com and search on XT X Tender nozzles.



UOPRK – PRESSURE REGULATOR KIT



A5200052 – FOAM MARKER AND FOAM

BOOM ACCESSORIES

											\$ (EX. GST)	\$ (INC. GST)	PROD. CAT.
UOPRK	Pressure regulator kit for use with most 12V pumps such as FloJet and SHURflo. Ideal for regulating pressure and flow when a small spray boom is being used										120.00	132.00	B
A5200052	Double-sided foam marker kit with in-cab switchbox for use on booms up to approximately 18m (depending on speed of travel) (kit includes foam droppers)										2,518.00	2,769.80	B

CROPAIR 300, 600 & 1000



HL300/600



HL600/800



HTP1000

KEY FEATURES

1. Brass roll-over nozzle bodies with non-drip diaphragm
2. Manual-tap control for left/right shut off of spray ring on each side
3. 15L handwash tanks for operator safety
4. Flushing tank
5. Large filling lid
6. Heavy-duty, galvanised frame

NOZZLE SELECTION SEE PAGE 58

CROPAIR 300

WIDTH: 1000MM LENGTH: 1300MM HEIGHT: 1100MM WEIGHT: 230KG

		\$ (EX. GST)	\$ (INC. GST)	PROD. CAT.
HL300/600	300L Linkage, Ssingle-speed, 615mm fan with adjustable pitch blades. AR 54 L/min high-pressure (40-bar) triple-diaphragm pump. Fitted with remote-mounted manual tap control. 5 x brass rollover nozzle bodies per side. Approximately 25-30 HP required	10,457.00	11,502.70	A

CROPAIR 600

WIDTH: 1550MM LENGTH: 1470MM HEIGHT: 1560MM WEIGHT: 390KG

		\$ (EX. GST)	\$ (INC. GST)	PROD. CAT.
HL600/800	600L Linkage, 2-speed, 815mm fan with adjustable pitch blades. AR 54 L/min high-pressure (40-bar) triple-diaphragm pump. Fitted with remote-mounted manual tap control. 6 x brass rollover nozzle bodies per side. Approximately 50 HP required	12,060.00	13,266.00	A

CROPAIR 1000 TRAILED

WIDTH: 1360MM LENGTH: 3200MM HEIGHT: 2300MM WEIGHT: 800KG

		\$ (EX. GST)	\$ (INC. GST)	PROD. CAT.
HTP1000-815	1000L Trailed, 2-speed, 815mm fan with adjustable pitch blades. AR 54 L/min high-pressure (40-bar) triple-diaphragm pump. Fitted with remote-mounted manual tap control. 6 x brass rollover nozzle bodies per side. Approximately 50 HP required	22,463.00	24,709.30	A

CROPAIR OPTIONS

		\$ (EX. GST)	\$ (INC. GST)
I-S4021	Electric left/right 2-section on/off solenoids, electric pressure adjustment with integrated pressure filter and master switch with dump solenoid	3,759.00	4,134.90

200 LITRE

CROPAIR SELF PROPELLED



LINEAR TOWER CROPAIR SELF-PROPELLED SPRAYER



CROPAIR SELF PROPELLED SPRAYER

CROPAIR SELF-PROPELLED SPRAYER

DIMENSIONS WITHOUT ACCESSORIES - WIDTH: 80CM LENGTH: 120CM HEIGHT: 110CM WEIGHT: 338 - 350KG DRY WEIGHT

		\$ (EX. GST)	\$ (INC. GST)	PROD. CAT.
MM2204014	Self Propelled machine, designed for application of plant protection products in intensive crops of vineyards, greenhouses and orchards. Self supporting steel tubular frame, a hydrostatic transmission, 200 - 300L tank capacity, 40L/min 40 Bar AR Pump, coupled to GX390 4 stroke Honda engine. Ideal for use in greenhouses, spans to a width of 80cm.	23,950.00	26,345.00	D

LINEAR TOWER CROPAIR SELF-PROPELLED SPRAYER

DIMENSIONS WITHOUT ACCESSORIES - WIDTH: 80CM LENGTH: 120CM HEIGHT: 110CM WEIGHT: 338 - 350KG DRY WEIGHT

		\$ (EX. GST)	\$ (INC. GST)	PROD. CAT.
MM2204014LT	Self Propelled machine, designed for application of plant protection products in intensive crops of vineyards, greenhouses and orchards. Self supporting steel tubular frame, a hydrostatic transmission, 200 - 300L tank capacity, 40L/min 40 Bar AR Pump, coupled to GX390 4 stroke Honda engine. Ideal for use in greenhouses, spans to a width of 80cm.	25,950.00	28,545.00	D

OPTIONS

		\$ (EX. GST)	\$ (INC. GST)
A4670610-SR100	Visio spray monitor fitted to measure spray application rate, litres used, area, distance and speed.	2,610.00	2,871.00

SMALL TRAILED 12-VOLT

TRAILPAK 300

SCAN FOR
VIDEO



UA300B/20S/6BX

KEY FEATURES

- Translucent UV-stabilised tank with large sump and graduated markings
- Large, easy-access lid with filling strainer
- Easy-access suction filter and regulator for pressure and flow adjustment
- Rugged, one-piece chassis
- Flotation tyres on sturdy axle
- Safety hitch for safe towing and parking stand
- 12V, 20 L/min (open-flow) pump to enable use with booms up to 6m
- Standard with hose reel, 10m of 10mm hose and spray lance



UA300B FITTED WITH NEW MBX06 BOOM
– MODEL UA300B/20S/6BX

Boom fitted models:

- AirMix air-induction low-drift nozzles fitted standard
- Fully protected non-drip nozzle bodies on stainless-steel boom tubes
- Spring-loaded breakaways to protect boom arms

UA300B 12-VOLT RANGE

WIDTH: 1200MM LENGTH: 2000MM HEIGHT: 1200MM WEIGHT: 120KG

		\$ (EX. GST)	\$ (INC. GST)	PROD. CAT.
UA300B	Trailer with hitch and 300L tank only – no pump, boom or gun	2,738.00	3,011.80	A
UA300B/20.1S	Trailing 300L sprayer, 20 L/min 12V pump, regulator kit, 10m of 10mm hose on handy hose reel with spray lance – ideal for spot sprayers	3,896.00	4,285.60	A
UA300B/20S/4BX	Trailing 300L sprayer, 20 L/min 12V pump, regulator kit, 10m of 10mm hose on handy hose reel with spray lance and 4m boom	5,321.00	5,853.10	A
UA300B/20S/6BX	Trailing 300L sprayer, 20 L/min 12V pump, regulator kit, 10m of 10mm hose on handy hose reel with spray lance and 6m boom	5,635.00	6,198.50	A
UA300B/20S/XTKI	Trailing 300L sprayer, 20 L/min 12V pump, regulator kit, 10m of 10mm hose on handy hose reel with spray lance and XT boom kit fitted	4,615.00	5,076.50	A

Disclaimer: dimensional and weight information supplied is for base model only with no options. This information is subject to change without notice.

SMALL TRAILED MOTORISED

TRAILPAK 300

Self-contained mobile spraying, designed to be towed behind an ATV, UTV or small tractor.



MVB5-5

KEY FEATURES

- Translucent UV-stabilised tank with large sump and graduated markings
- Large, easy-access lid with filling strainer
- Easy-access suction filter and regulator for pressure and flow adjustment
- Rugged, one-piece chassis
- Flotation tyres on sturdy axle
- Safety hitch for safe towing and parking stand
- 25 L/min Honda-powered pump
- Standard with hose reel, 10mm hose and spray lance
- Optional upgrade to auto-rewind remote control RetraSpray reel



UA300B/20/
HR30G

POWERED by
HONDA™

UA300B MOTORISED RANGE

WIDTH: 1200MM LENGTH: 2000MM HEIGHT: 1200MM WEIGHT: 120KG

		\$ (EX. GST)	\$ (INC. GST)	PROD. CAT.
UA300B/20/HR20G	Honda-powered AR252 pump fitted to the UA300B trailing sprayer with 20m of 10mm hose on hose reel with RL10 spray lance	5,466.00	6,012.60	A
UA300B/20/HR30G	Honda-powered AR252 pump fitted to the UA300B trailing sprayer with 30m of 10mm hose on heavy-duty steel hose reel with RL10 spray lance	6,198.00	6,817.80	A
UA300B/20/100RC	Honda-powered AR252 pump fitted to the UA300B trailing sprayer auto-rewind remote control RetraSpray reel fitted	9,979.00	10,976.90	A
UA300B/303/MVB5	Honda-powered AR303 pump fitted to the UA300B trailing sprayer with 5 nozzle per side Vertiboom fitted. Ideal for small horticultural growers	7,324.00	8,056.40	A

Disclaimer: dimensional and weight information supplied is for base model only with no options. This information is subject to change without notice.

SMALL TRAILED

TRAILPAK 1100 & 1500

A cost-effective sprayer for pasture spraying, small cropping areas and dairy farms.



OPTIONS SEE PAGE 23

KEY FEATURES

1. 1100 and 1500L tank options
2. Remote tank drain valve and large sump
3. Large, easy-access filling lid with filling strainer
4. Easy-access suction filter with shut-off to allow for in-field cleaning
5. Fully galvanised chassis fitted with sprung axle to protect from premature wear
6. 11.5/80 x 15.3 tubeless agricultural tyres on steel rims
7. Adjustable height swivel towing eye
8. Large side step for easy tank access
9. Liquid fertiliser-ready poly 3-diaphragm pump fitted standard (PTO shaft supplied)



BT1100 SHOWN WITH ELECTRIC CONTROLLER OPTION

Selection of boom sizes available.

		\$ (EX. GST)	\$ (INC. GST)	PROD. CAT.
BT-1100	Base model 1100L trailed sprayer with galvanised chassis, leaf-spring single axle, PTO-drive 80 L/min AR triple-diaphragm pump (0–20 bar rated), ARUCM 5-manual tap control unit, 20L handwash tank and jockey wheel. No boom or reel fitted – add from options next page. PTO supplied	11,400.00	12,540.00	A
BT-1500	Base model 1500L trailed sprayer with galvanised chassis, leaf-spring single axle, PTO-drive 80 L/min AR triple-diaphragm pump (0–20 bar rated), ARUCM 5-manual tap control unit, 20L handwash tank and jockey wheel. No boom or reel fitted. PTO supplied	11,700.00	12,870.00	A

Note: ensure your vehicle is approved for the laden or trailed weight of the sprayer you have chosen.

TRAILPAK 1100/1500

OPTIONS



8 TO 12M BOOM OPTIONS



I-E2032 ELECTRIC CONTROLS



GB383899000V AIRBAG SUSPENSION



AR140LFP-C POLY PUMP



A5200052 FOAM MARKER



TOPXD-01

BOOM

		\$ (EX. GST)	\$ (INC. GST)	SEE MORE
MAX08L	8m MAX series manual cross-fold boom with self-leveller fitted at fixed height (can be adjusted by unbolting and refitting). 2,055mm folded width	4,122.00	4,534.20	14
MAX10L	10m MAX series manual cross-fold boom fitted. Specifications as per MAX08L above	5,024.00	5,526.40	14
MAX12L	12m MAX series manual cross-fold boom fitted. Specifications as per MAX08L above	5,706.00	6,276.60	14
GB383899000V	Parallelogram airbag suspension system for booms	3,587.00	3,945.70	Above

PUMP

		\$ (EX. GST)	\$ (INC. GST)	SEE MORE
AR140LFP-C	140 L/min PTO pump in lieu of standard 80 L/min model	767.00	843.70	43
AR70-5H	AR70 Honda-powered motorised pump in lieu of PTO drive AR80	2,844.00	3,128.40	45

ELECTRIC AND AUTO SPRAY-RATE CONTROLLERS (IF BOOM IS FITTED)

		\$ (EX. GST)	\$ (INC. GST)	SEE MORE
LT-FMIE2032A	3-section control of 3 boom sections and pressure control	1,827.00	2,009.70	13
LT-FMBA5000GEO3	3-section auto-rate spray controller for fully automatic spray rate control	5,861.00	6,447.10	13

FOAM MARKER, GPS AND EXTRA OPTIONS

		\$ (EX. GST)	\$ (INC. GST)	SEE MORE
A5200052	Double-sided foam marker fitted	2,619.00	2,880.90	17
TOPXD-01	Basic GPS mapping system in lieu of a foam marker. Ideal for knowing where you have applied	4,760.00	5,236.00	56

ELECTRIC REELS

RETRASPRAY

Take the work out of gun spraying with Croplands-exclusive RetraSpray retractable reel, complete with SupaSlip hose.



OPTIONS SEE PAGES 32-33

KEY FEATURES

1. 12V 1/5HP low-rev motor directly coupled to the reel
2. 100m high-quality SupaSlip hose
3. Push-button hose retraction and remote-control rewind standard, includes roller guides for hose
4. Connect to 12V DC power source using heavy-duty power cable supplied



B26.901.165MK2

Choose your gun and add to your order



RL10

		\$ (EX. GST)	\$ (INC. GST)	PROD. CAT.
RSRL3-100RC	RetraSpray single reel with 100m hose and remote control	4,500.00	4,950.00	D
B26.901.165MK2	Turbo400 with metal grip and protected lever, 50 bar (725 psi)	219.00	240.90	B
RL10	RL10 gun with 500mm steel lance, adjustable nozzle, suits 100 model	84.00	92.40	B

Note: guns sold separately.

ELECTRIC REELS

TRAYPAK

Croplands traymount sprayers are full-operation spraying systems designed to fit on the back of your ute or RTV to give portable delivery of high-pressure, large-volume spray application, whether you're spraying weeds, carting water or fighting fires.



US60F/40/100RT3



US30F/30/100R3



US500/30/100R3

UNIT	WIDTH	LENGTH	HEIGHT	WEIGHT
US20F/25/100R3	1360mm	990mm	805mm	132kg
US30F/30/100R3	1360mm	990mm	805mm	146kg
US500/30/100R3	1200mm	1700mm	1200mm	218kg
US500/40/100RT3	1200mm	1700mm	1200mm	248kg
US60F/30/100R3	1255mm	1575mm	990mm	197kg
US60F/40/100RT3	1300mm	1575mm	990mm	237kg

Disclaimer: dimensional and weight information supplied is for base model only with no options. This information is subject to change without notice.

		\$ (EX. GST)	\$ (INC. GST)	PROD. CAT.
US20F/25/100R3	200L traymount sprayer with galvanised frame, Honda-powered 25 L/min pump, 12V auto-retractable RetraSpray reel with 100m of non-kink spray hose and Turbo400 gun. 6L handwash tank	8,376.00	9,213.60	A
US30F/30/100R3	300L traymount sprayer with galvanised frame, Honda-powered 35 L/min pump, 12V auto-retractable RetraSpray reel with 100m of non-kink spray hose and Turbo400 gun. 6L handwash tank	8,903.00	9,793.30	A
US500/30/100R3	500L traymount sprayer with galvanised frame, Honda-powered 35 L/min pump, 12V auto-retractable RetraSpray reel with 100m of non-kink spray hose and Turbo400 gun	9,935.00	10,928.50	A
US500/40/100RT3	500L traymount sprayer with galvanised frame, Honda-powered 46.3 L/min pump, twin 12V auto-retractable RetraSpray reels with 100m of non-kink spray hose and Turbo400 guns	14,613.00	16,074.30	A
US60F/30/100R3	600L traymount sprayer with galvanised frame, Honda-powered 35 L/min pump, 12V auto-retractable RetraSpray reel with 100m of non-kink spray hose and Turbo400 gun. 6L handwash tank	9,888.00	10,876.80	A
US60F/40/100RT3	600L traymount sprayer with galvanised frame, Honda-powered 46.3 L/min pump, twin 12V auto-retractable RetraSpray reels with 100m of non-kink spray hose and Turbo400 guns. 6L handwash tank	14,508.00	15,958.80	A

MANUAL REELS

TRAYPAK

Croplands motorised sprayers are powered by genuine Honda motors with larger diaphragm pumps to give better spray pressure for those larger jobs.

POWERED by
HONDA™

KEY FEATURES

1. Heavy-duty hot-dip galvanised frame with carry handles
2. UV-stabilised tank with level markings
3. Large filling lid with basket strainer
4. Large sump for total emptying and easy draining and clean out
5. Genuine Honda motor to power the reliable AR diaphragm pump
6. Steel hose reel with galvanised mount, 30 metres of high-quality hose and Turbo400 gun



US20F/252/HR30

SCAN FOR VIDEO



US30F/30/HR30TG



US60F/30/HR30TG



US600F/40/TWIN



UNIT	WIDTH	LENGTH	HEIGHT	WEIGHT
US20F/252/HR30	1275mm	1015mm	725mm	110kg
US30F/30/HR30TG	1275mm	1015mm	725mm	115kg
US60F/30/HR30TG	1255mm	1475mm	990mm	197kg
US60F/40/TWIN	1255mm	1475mm	990mm	237kg

Disclaimer: dimensional and weight information supplied is for base model only with no options. This information is subject to change without notice.

		\$ (EX. GST)	\$ (INC. GST)	PROD. CAT.
US20F/252/HR30	New 200L traymount sprayer with galvanised frame, Honda-powered 25 L/min AR pump. Manual two-tap controls, 30m hose reel and Turbo400 gun. 6L handwash tank	4,560.00	5,016.00	A
US30F/30/HR30TG	New 300L traymount sprayer with galvanised frame, Honda-powered 35 L/min AR pump. Manual two-tap controls, 30m hose reel and Turbo400 gun. 6L handwash tank	5,456.00	6,001.60	A
US60F/30/HR30TG	New 600L traymount sprayer with galvanised frame, Honda-powered 35 L/min AR pump. Manual two-tap controls, 30m hose reel and Turbo400 gun. 6L handwash tank	6,068.00	6,674.80	A
US60F/40/TWIN	New 600L traymount sprayer with galvanised frame, Honda-powered 46.3 L/min AR pump. Manual two-tap controls, twin 30m hose reels and Turbo400 guns. 6L handwash tank	7,650.00	8,415.00	A



US500/30/HR30TG



US500/40/TWIN

UNIT	WIDTH	LENGTH	HEIGHT	WEIGHT
US500/30/HR30TG	1200mm	1700mm	1200mm	220kg

Disclaimer: dimensional and weight information supplied is for base model only with no options. This information is subject to change without notice.

UNIT		\$ (EX. GST)	\$ (INC. GST)	PROD. CAT.
US500/30/HR30TG	TrayPak 500L, AR30 pump, reel with 30m hose and Turbo400 gun, galvanised skid frame	6,245.00	6,869.50	A
US500/70/HR30TG	TrayPak 500L, AR70 pump, reel with 30m hose and Turbo400 gun, galvanised skid frame. AR70 pump is ideal for use with a range of booms (see page 18 and 19)	6,491.00	7,140.10	A
US500/40/TWIN	TrayPak 500L, AR40 pump, twin reel both with 30m hose and Turbo400 gun, galvanised skid frame	7,657.00	8,422.70	A

200 | 300 LITRE

CROPPAK

Easy to transport and manoeuvre, Croplands 12V powered sprayers are well suited for repeat, spot spray operations.

OPTIONS SEE PAGES 31-32

KEY FEATURES

1. Rugged translucent tank, UV-stabilised with large filling lid and drain
2. 3-stage filtration - filling screen under lid, suction filter and pressure filter in lance handle
3. Metal lance with adjustable nozzle. Clips into lid for easy storage
4. New galvanised frame for easy handling
5. 6 metres of high-quality 20-bar spray hose fitted
6. Heavy-duty 12V power lead with rocker-switch
7. High-quality electrical connector to pump with waterproof plug for quick and reliable connection



US200F - TANK & FRAME



US300F/15/HR

LANCE OPTIONS



SW-LANCE-ASSY



SW-LANCE-ADJ-AS

UNIT	WIDTH	LENGTH	HEIGHT
US200F	1320mm	610mm	690mm
US200F/15	1320mm	610mm	690mm
US300F/15	1325mm	610mm	850mm

Disclaimer: dimensional and weight information supplied is for base model only with no options. This information is subject to change without notice.

		\$ (EX. GST)	\$ (INC. GST)	PROD. CAT.
US200F	New 200L CropPak with new galvanised frame, on-demand 6.8 L/min open-flow pump. 10m spray hose standard with spray lance. Power lead with on/off switch provided	1,336.00	1,469.60	A
US200F/15	New 200L CropPak with new galvanised frame, on-demand 15.1 L/min open-flow pump, regulator and gauge. 3-way valve enables connection to a boom. 10m spray hose standard with spray lance. Power lead with on/off switch provided	1,802.00	1,982.20	A
US300F/15	New 300L CropPak with new galvanised frame, on-demand 15.1 L/min open-flow pump, regulator and gauge. 3-way valve enables connection to a boom. 10m spray hose standard with spray lance. Power lead with on/off switch provided	1,993.00	2,192.30	A
US200F/15/HR	New 200L CropPak with galvanised frame, on-demand 15.1 L/min open-flow pump, regulator and gauge. 3-way valve enables connection to a boom. 10m spray hose standard with Swissmex spray gun and lance. Power lead with on/off switch provided. Fitted with 10m hose reel.	2,215.00	2,436.50	A
US300F/15/HR	New 300L CropPak with galvanised frame, on-demand 15.1 L/min open-flow pump, regulator and gauge. 3-way valve enables connection to a boom. 10m spray hose standard with Swissmex spray gun and lance. Power lead with on/off switch provided. Fitted with 10m hose reel.	2,405.00	2,645.50	A

30 | 60 | 100 LITRE

CROPPAK

KEY FEATURES

1. Rugged translucent tank, UV-stabilised with large filling lid and drain
2. 3-stage filtration - filling screen under lid, suction filter and pressure filter in lance handle
3. Metal lance with adjustable nozzle. Clips into lid for easy storage
4. Carry handles for easy handling
5. 6 metres of high-quality 20-bar spray hose fitted
6. Heavy-duty 12V power lead with rocker-switch
7. High-quality electrical connector to pump with waterproof plug for quick and reliable connection



OPTIONS SEE PAGES 31-32



		\$ (EX. GST)	\$ (INC. GST)	PROD. CAT.
US30S	30L CropPak, on-demand 6.8 L/min open-flow pump, 6m of spray hose, spray lance and electrical power lead with on/off switch WIDTH: 280MM LENGTH: 640MM HEIGHT: 380MM WEIGHT: 9KG	665.00	731.50	A
US60S	As above with 60L CropPak WIDTH: 440MM LENGTH: 760MM HEIGHT: 440MM WEIGHT: 11KG	711.00	782.10	A
US100S	As above with 100L CropPak WIDTH: 460MM LENGTH: 1000MM HEIGHT: 460MM WEIGHT: 14KG	762.00	838.20	A
US100A/15	100L CropPak, on-demand 15 L/min open-flow pump, pressure regulator and gauge, 6m of spray hose, spray lance and electrical power lead with on/off switch WIDTH: 460MM LENGTH: 1000MM HEIGHT: 460MM WEIGHT: 14KG	880.00	968.00	A

Disclaimer: dimensional and weight information supplied is for base model only with no options. This information is subject to change without notice.



		\$ (EX. GST)	\$ (INC. GST)	PROD. CAT.
AR30	Annovi Reverberi 38L CropPak fitted with AR 3.8L/min 12V pump, 3m of spray hose, spray lance and electrical power lead with on/off switch. WIDTH: 330MM LENGTH: 740MM HEIGHT: 300MM WEIGHT: 8KG	277.00	304.70	A
AR60	Annovi Reverberi 60L CropPak fitted with AR 8.3L/min 12V pump, 5m of spray hose, spray lance and electrical power lead with on/off switch. WIDTH: 460MM LENGTH: 860MM HEIGHT: 310MM WEIGHT: 11KG	365.00	401.50	A
AR100	Annovi Reverberi 100L CropPak fitted with AR 8.3L/min 12V pump, 5m of spray hose, spray lance and electrical power lead with on/off switch. WIDTH: 370MM LENGTH: 880MM HEIGHT: 530MM WEIGHT: 14KG	409.00	449.90	A
AR100/15	Annovi Reverberi 100L CropPak fitted with AR 15.1L/min 12V pump and pressure regulator kit and gauge, 5m of spray hose, spray lance and electrical power lead with on/off switch. WIDTH: 370MM LENGTH: 880MM HEIGHT: 530MM WEIGHT: 14KG	568.00	624.80	A

NEW

ANNOVI REVERBERI CROPPAK

PORTABLE SPRAYERS

KNAPSACKS

SCAN FOR VIDEO



KEY FEATURES

1. Adjustable nozzle
2. Long lance
3. Safer port – wide 5½" diameter port with filling strainer
4. Large 15L tank
5. Easy to clean – strong polyethylene tank with UV inhibitors for long life
6. Easy to handle – comfortable handgrip with lever lock
7. In-built pressure filter
8. Dual-piston/diaphragm pump – non-leak, high-quality dual-piston/diaphragm pump (up to 6 bar) with Viton seals and a safety diaphragm – for wear resistance and reliability
9. Padded straps – wide, non-absorbent polyester straps with heavy-duty padding for strength, comfort and safety
10. Sturdy design – one-piece handle folds for easy storage
11. In-built agitator
12. Lid lance clips – for easy storage and carrying
13. Carry handle – offers convenience



PAKMAN (FITTED TO SPRAYER)

Chemical resistant foam back protector, designed to significantly increase comfort for prolonged spraying needs. Fits SW503 15L knapsack sprayers. A must for making spraying much more comfortable

		\$ (EX. GST)	\$ (INC. GST)	PROD. CAT.
SW503	Knapsack 15L sprayer with piston/diaphragm	261.00	287.10	C
PAKMAN	Back protector for SW503	98.00	107.80	C

INDUSTRIAL



SW189C

Heavy-duty 15L knapsack designed for industrial use (diesel compatible); wide filling neck, rugged shut-off gun, adjustable nozzle, in-built pressure filter, brass lance. Lance clips into the handle for storage and transport



SW322-315

High-quality, heavy-duty 9L compression sprayer for use with selected solvents and diesel; wide filling neck, rugged shut-off gun, adjustable nozzle, pressure relief valve, in-built pressure filter, brass lance. Lance clips into the handle for storage and transport



SW320-310

The Acid Sprayer resists hydrochloric muriatic and phosphoric acids. Ideal for staining and etching concrete, and dissolving of rust on metal surfaces

AGRICULTURAL



SW319

High-quality, heavy-duty 5L compression sprayer; wide filling neck, rugged shut-off gun, adjustable nozzle, pressure relief valve, in-built pressure filter, brass lance. Lance clips into the handle for storage and transport



SW320

High-quality, heavy-duty 7L compression sprayer; wide filling neck, rugged shut-off gun, adjustable nozzle, pressure relief valve, in-built pressure filter, brass lance. Lance clips into the handle for storage and transport

BATTERY POWERED



ASBBS-16A

Rechargeable 12-volt sealed lithium ion battery; voltmeter to see charge level at a glance. Large filling lid. 12-volt diaphragm pump for positive spraying pressure



AR16

Annovi Reverberi 16L 20-volt lithium ion battery powered knapsack. Hassle-free and fuel-free. Easy to fill large screw cap with filter. Equipped with cushioned straps for extra comfort. Four nozzles for a variety of applications. 1.5L/min pump fitted. Battery base charger included

		\$ (EX. GST)	\$ (INC. GST)	PROD. CAT.
SW189C	Knapsack 15L sprayer (diesel)	228.00	250.80	C
SW322-315	Compression 9L sprayer – solvent model	213.00	234.30	C
SW320-310	Acid knapsack 7L sprayer	195.00	214.50	C
SW319	Compression 5L sprayer	141.00	155.10	C
SW320	Compression 7L sprayer	161.00	177.10	C
ASBBS-16A	16L lithium ion battery powered knapsack with 3.2L/min pump. Suitable for small boom application.	329.00	361.90	A
AR16	AR 16L lithium ion battery powered knapsack with 1.5L/min pump. Ideal for single spot spraying.	280.00	308.00	A

ACCESSORIES

CROPPAK & SWISSMEX

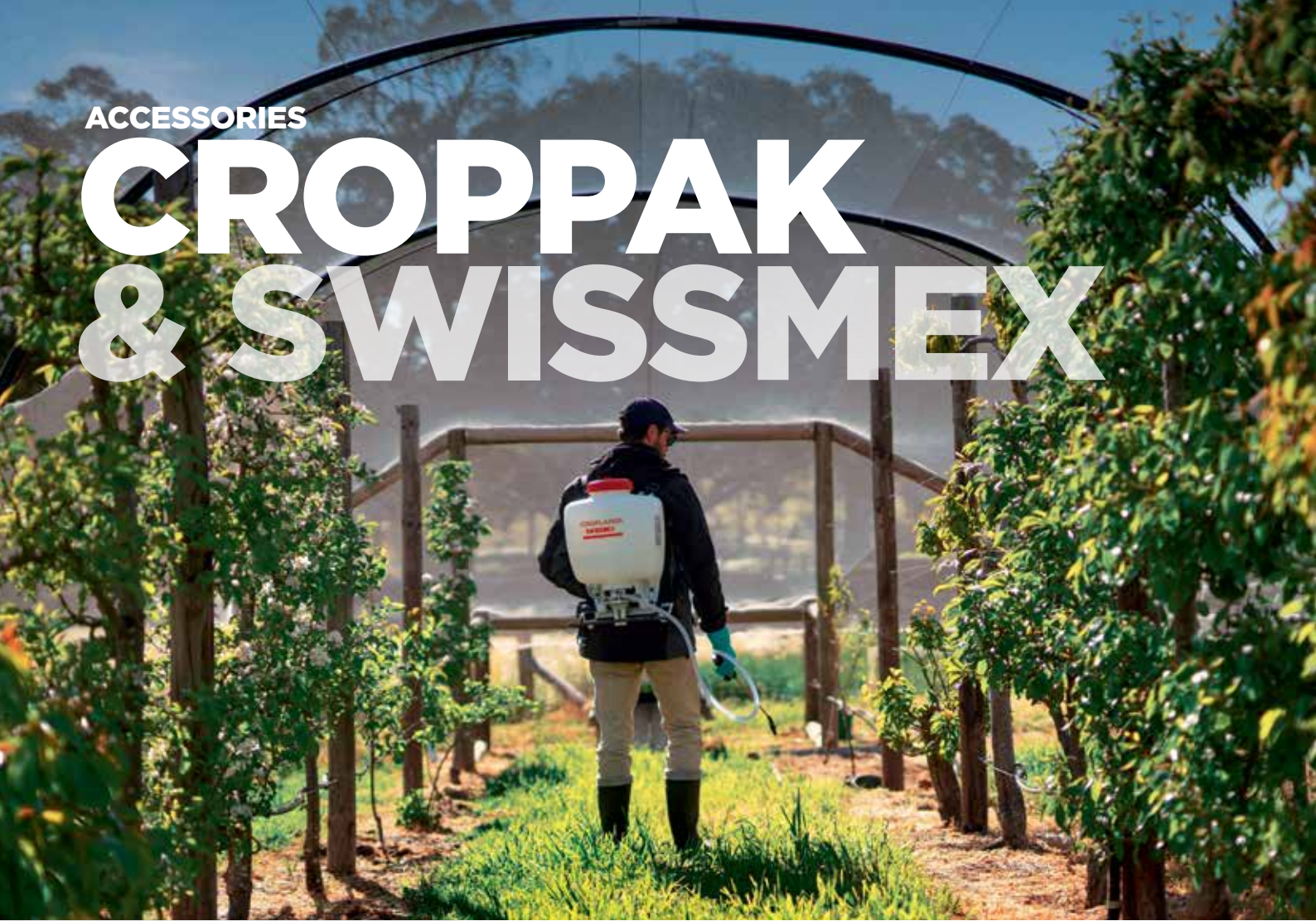

Spray lances for our range of CropPak sprayers, knapsack sprayers and compression sprayers.



SPRAY LANCES

		\$ (EX. GST)	\$ (INC. GST)	PROD. CAT.
SW-LANCE-ASSY	Complete spray gun with brass lance, adjustable nozzle and hose connector fitted (in-built pressure filter)	52.00	57.20	C
SW-LANCE-ADJ-AS	Complete spray gun with extendable fibreglass lance, adjustable nozzle and hose connector fitted (in-built pressure filter)	65.00	71.50	C



EXTENSION LANCES

		\$ (EX. GST)	\$ (INC. GST)	PROD. CAT.
SW219-142C	1000mm spray lance extension to fit Swissmex trigger assembly, with nozzle	34.00	37.40	C
SW219-143C	1500mm spray lance extension to fit Swissmex trigger assembly, with nozzle	36.00	39.60	C
SW219-146C	2000mm spray lance extension to fit Swissmex trigger assembly, with nozzle	43.00	47.30	C
SW803-085	Brass spray lance, 520mm (standard lance), nozzle not included	30.00	33.00	C
SW219-236C	Telescopic lance (to 940mm), with nozzle	30.00	33.00	C



SW219-140C

 SW219-147C 2-NOZZLE BOOM
(NARROW)

SPRAY BOOMS TO FIT THE LANCE ASSEMBLY

		\$ (EX. GST)	\$ (INC. GST)	PROD. CAT.
SW219-147C	2-nozzle boom, narrow	27.00	29.70	C
SW219-140C	2-nozzle boom, 500mm	28.00	30.80	C
SW219-148C	2-nozzle boom, 750mm	34.00	37.40	C
SW219-138C	3-nozzle boom, 1000mm	41.00	45.10	C
SW219-151C	3-nozzle boom, 1500mm	47.00	51.70	C
SW219-282C	4-nozzle boom, 1500mm	79.00	86.90	C



SW803-262C



SW219-089C



XR8003-VK



TDAM-AN-04

NOZZLES

		\$ (EX. GST)	\$ (INC. GST)	PROD. CAT.
SW803-262C	Plastic adjustable nozzle complete with cap and gasket	6.00	6.60	C
SW219-089C	Brass adjustable nozzle complete with cap and gasket	25.00	27.50	C
XR8003-VK	80° flat-fan nozzle for use with spray guard or lance	13.00	14.30	B
TDAM-AN-04	AirMix® anvil type air-induction flat-fan nozzle	18.00	19.80	C



SW219-099



SW219-117

LANCE ACCESSORIES

		\$ (EX. GST)	\$ (INC. GST)	PROD. CAT.
SW219-099	Herbicide spray guard, 400mm, large	17.00	18.70	C
SW219-117	Herbicide spray guard, 220mm, small	10.00	11.00	C
AT15128	Constant flow valve, 3 bar	148.00	162.80	C



SW808-073C



SW808-014



SW502-191



SWRPK503

COMMON REPLACEMENT COMPONENTS AND KITS

		\$ (EX. GST)	\$ (INC. GST)	PROD. CAT.
SW808-073C	Complete trigger assembly	25.00	27.50	C
SWRPK120	Repair/service kit for SW319 and SW320	30.00	33.00	C
SWRPK189	Repair/service kit for SW189	16.00	17.60	C
SWRPK189C	Repair/service kit for SW189C	49.00	53.90	C
SWRPK503	Repair/service kit for SW503 (diaphragm not included in kit)	23.00	25.30	C
SW503-031	Diaphragm to suit SW503 Knapsack	14.00	15.40	C
SW502-191	Elbow connector 90° – outlet to hose from tank	19.00	20.90	C
SW808-014	Hose tail to fit 3/8" (10mm) hose – attached to back of trigger assembly	3.50	3.85	C
SW502-001C	Red tank lid – suits all models (pictured left)	24.00	26.40	C
SW501-002	Lid seal (pictured left)	5.50	6.05	C
SW501-004	Lid strainer (pictured left)	6.50	7.15	C

ACCESSORIES

REELS & PRESSURE GAUGE

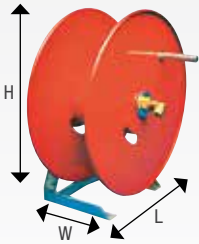

L-R0240

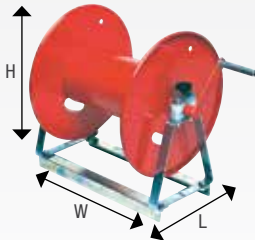

L-R0250

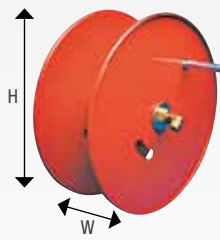

L-R0260

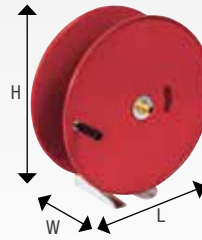

L-R0230

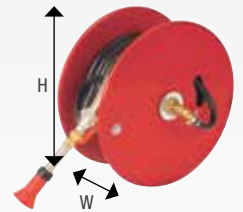

L-R2412

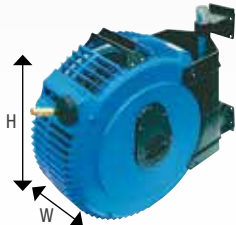

L-R3000

UNIT	WIDTH	LENGTH	HEIGHT	WEIGHT
L-R0240	270mm	450mm	560mm	–
L-R0250	540mm	450mm	510mm	–
L-R0260	200mm	–	450mm	–

UNIT	WIDTH	LENGTH	HEIGHT	WEIGHT
L-R0230	270mm	580mm	630mm	–
L-R2412	270mm	450mm	560mm	–
L-R3000	220mm	–	490mm	–

REELS

		\$ (EX. GST)	\$ (INC. GST)	PROD. CAT.
L-R0240	Base-mount model, 50m capacity* (bare reel)	870.00	957.00	A
L-R1412	Base-mount model comes with 30m of 10mm spray hose and Turbo400 spray gun	1,050.00	1,155.00	A
L-R0260	Side-mount (with bracket), 50m capacity* (bare reel)	626.00	688.60	A
L-R2412	Side-mount (with bracket), comes with 30m of 10mm spray hose and Turbo400 spray gun	929.00	1,021.90	A
L-R2412HP	Replacement reel for US500/30/HR30TG high pressure (40 bar)	1,125.00	1,237.50	A
L-R0250	Large-base mount model, 100m capacity* (bare reel)	1,441.00	1,585.10	D
L-R0230	Slim-line steel hose reel, galvanised base-mount model, 100m capacity* (bare reel)	991.00	1,090.10	D
L-R3000	High-impact poly reel, spring retractable; 15m of 10mm spray hose and threaded end-fitting (no gun fitted)	404.00	444.40	D

*All bare capacities are for 10mm spray hose. L=length, W=width, H=height; dimensions may change without notice and do not include side-bracket on side-mount reels. Dimensional and weight information supplied is for base.



L-G1432



L-G1426



L-G1626



A908006

PRESSURE GAUGES GLYCERINE-FILLED GAUGES IN 63MM AND 100MM SIZES		MAX PRESS BAR	MAX PRESS KPA	MAX PRESS PSI	\$ (EX. GST)	\$ (INC. GST)	PROD. CAT.
A908006	Pressure gauge, 40mm, 0–600 kPa CBM	6	600	90	45.00	49.50	B
L-G1426	Isometric pressure gauge, 63mm, ¼" bottom-entry	25	2500	360	44.00	48.40	D
L-G1425	Pressure gauge, 63mm, ¼" bottom-entry	25	2500	360	33.00	36.30	D
L-G1430	Pressure gauge, 63mm, ¼" bottom-entry	40	4000	580	33.00	36.30	D
L-G1432	Pressure gauge, 63mm, ¼" bottom-entry	60	6000	870	33.00	36.30	D
L-G1602	Pressure gauge, 100mm, ¼" bottom-entry	25	2500	360	63.00	69.30	D
L-G1611	Pressure gauge, 100mm, ⅜" bottom-entry	16	1600	230	84.00	92.40	D
L-G1612	Pressure gauge, 100mm, ⅜" bottom-entry	25	2500	360	84.00	92.40	D
L-G1660	Pressure gauge, 100mm, ⅜" bottom-entry	60	6000	870	84.00	92.40	D
L-G1626	Isometric pressure gauge, 100mm, ⅜" bottom-entry	25	2500	360	102.00	112.20	D

ACCESSORIES

SPRAY GUNS & LANCES



SW-LANCE-ASSY



SW-LANCE-ADJ-AS



RL10

SPRAY GUNS & LANCES

		\$ (EX. GST)	\$ (INC. GST)	PROD. CAT.
SW-LANCE-ASSY	Swissmex gun and lance	52.00	57.20	C
SW-LANCE-ADJ-AS	Swissmex gun and extendable lance	65.00	71.50	C
RL10	RL10 gun with 500mm steel lance, adjustable nozzle	84.00	92.40	B



AA30L-PP



AA30L-1/4



AA31

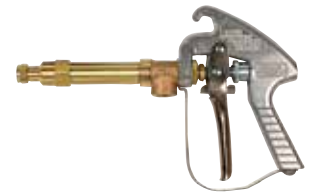

AA43HA-8 AND AA43LA-8



B26.901.165MK2



B46.901.46RG



B7.901.10



B35.901.16

SPRAY GUNS

		\$ (EX. GST)	\$ (INC. GST)	PROD. CAT.
AA30L-PP	TeeJet GunJet poly spray gun, 10 bar (150 psi)	130.00	143.00	B
AA30L-1/4	TeeJet GunJet drip-free spray gun, 17 bar (250 psi)	164.00	180.40	B
AA31	TeeJet forged brass trigger gun, 35 bar (500 psi)	176.00	193.60	B
AA43HA-8	TeeJet heavy-duty high-pressure gun, 55 bar (800 psi)	386.00	424.60	B
AA43LA-8	TeeJet heavy-duty medium-pressure gun, 14 bar (200 psi)	399.00	438.90	B
B26.901.165MK2	Turbo400 with metal grip and protected lever, 50 bar (725 psi)	219.00	240.90	B
B46.901.46RG	Turbo400RG gun with ergonomic grip and positive-notch droplet selection, 40 bar (580 psi)	259.00	284.90	B
B7.901.10	Evolution turbine gun, 60 bar (850 psi)	399.00	438.90	B
B35.901.16	Spot-spray gun, pistol type, 40 bar (580 psi)	159.00	174.90	B

ACCESSORIES

CHEMICAL MIXING & TRANSFER



CHEMPAK



A5033301

30L CHEMICAL MIXER

1. Can handle liquids, powders and granulated products
2. Venturi suction system with integrated drain valve
3. Three venturi options to adapt to the pump type being used
4. Easy-to-understand tap controls for chemical mixing, mixer rinse and container cleaning system
5. Integrated lifting handle
6. Simple mounting system to ensure easy fit up to existing sprayers
7. Optional suction probe



L-H9351A

60L CHEMICAL MIXER

1. Large access lid, fully sealed for safety
2. External and internal level markings
3. Dual-filling and product-agitation jets for rapid mixing
4. Container rinse nozzle capable of rinsing up to 20L containers
5. Mixer rinsing nozzle mounted directly under the lid for complete cleaning
6. Large taps for easy operation
7. Venturi with shut off valve
8. Sturdy handle and mount
9. Optional drop-down bracket available
10. High-flow capacity via large venturi



L-H9353B

STAND ALONE 60L MIXER

1. Trolley-mounted Croplands chemical mixer for stand-alone mixing operations
2. Same features as itemised on left unit without pump. Requires a pressurised water source to allow mixing, filling and venturi to operate correctly – the pump on the sprayer could be used
3. Unit with 240V pump best used where a water tank and power is available but no existing pressurised water source is available

CHEMPAKS

		\$ (EX. GST)	\$ (INC. GST)	PROD. CAT.
A5033301	30L chemical mixer and transfer hopper for use with smaller trailed sprayers, linkage sprayers and traymount units. Includes universal mount, 3-tap control bank, container rinse and venturi options to match to the pump size and type being used	2,253.00	2,478.30	B
L-H9351A	Croplands 60L chemical mixer and transfer hopper for use with larger trailed sprayers, linkage sprayers and traymount units. Includes universal mount, taps for mixing, container rinse and system cleaning. Cleaning nozzle mounted directly under lid for complete clean out. Internal and external markings	2,232.00	2,455.20	A
L-H9353B	Croplands 60L chemical mixer as described above on a handy trolley frame. Ideal for use at a chemical mixing station where an external pressurised water supply is available using an existing filling pump or similar	3,027.00	3,329.70	A
L-H9353C	Croplands 60L chemical mixer as described above on a handy trolley frame with 240V centrifugal pump fitted. Ideal for use at a chemical mixing station where an external water tank is available along with mains power to power the pump	5,250.00	5,775.00	A
L-H9355A	Optional spring-loaded drop-down mount for Croplands 60L mixer model L-H9351A. Ideal where operator height is an issue	1,061.00	1,167.10	D

CHEMICAL MIXING & TRANSFER



L-H9005 5L JUG



L-H9025 25L JUG

MIXING JUGS

L-H9001	Croplands calibrated 1L measuring jug	21.00	23.10	D
L-H9003	Croplands calibrated 3L measuring jug	34.00	37.40	D
L-H9005	Croplands calibrated 5L measuring jug	44.00	48.40	D
L-H9025	Croplands heavy-duty 25L calibrated mixing bucket with pouring spout	79.00	86.90	D

CHEMICAL TRANSFER

1. AgRunner chemical transfer unit for easy and accurate chemical transfer
2. Pump has nylon housing with Viton seals and multiple pump-chamber design to ensure long-life performance and durability



SHUFM-1100I



SHUSF-1105



L-H9556



L-H9562A



SHUSF-1105PTS1

CHEMICAL TRANSFER

		\$ (EX. GST)	\$ (INC. GST)	PROD. CAT.
SHUSF-1105PTS1	The AgRunner portable mini-bulk transfer system uses a 12V SHURflo chemical transfer pump for pumping liquid agricultural chemicals from bulk containers into chemical mixers or spray tanks. The unit has a handy carry frame to protect the pump unit, pump-mounted flow indicator, 6m of power cable, shut-off gun, 4m discharge hose, and a camlock inlet fitting with shut-off and 4m inlet hose	3,079.00	3,386.90	B
SHUSF-1105	12V SHURflo pump unit only, Viton valves, Santoprene diaphragms with internal bypass and 6m power cable. On/off switch on the pump. 29 L/min output at 15 psi pressure. Draws 14 amps	1,128.00	1,240.80	B
SHUFM-1100I	Pump-mounted electronic flowmeter with LCD display and long-life lithium battery	899.00	988.90	B
L-H9562A	Three-pin Envirodrum male coupling	964.00	1,060.40	D
L-H9556	Three-pin Envirodrum rinsing socket (must be connected to fresh-water source)	387.00	425.70	D

SAFETY

PROTECTIVE EQUIPMENT

SAFETY EQUIPMENT

		\$ (EX. GST)	\$ (INC. GST)	PROD. CAT.
L-H230*	Disposable protective suit. Suitable for single or limited repeat use for protection against dust while mixing chemicals. Not rainfast. *Denotes size as follows: 1 = Medium; 2 = Large; 4 = XL; 5 = XXL	22.00	24.20	D
L-H700*	Nitrile protective spray gloves, 330mm. *Denotes size as follows: 3 = size 10; 5 = size 11	10.00	11.00	D
L-H710*	Nitrile protective spray gloves, long, 460mm. *Denotes size as follows: 2 = size 9; 3 = size 10; 4 = size 11	24.00	26.40	D

COVERALLS L-H230

Tyvek® Barrier Man Coveralls are disposable coveralls designed to protect workers from hazardous materials, or sensitive products and processes from contamination by people. Available in white, sizes medium to XXL



GLOVES L-H700

Offers resistance to solvents and oils with good flexibility and dexterity. Excellent abrasion and puncture resistance. Available in sizes 9–11



RESPIRATOR L-H3016



FILTER KASCO-0601/19



MASK L-H3300

Please note: once opened replace after 6 months.

RESPIRATORS

		\$ (EX. GST)	\$ (INC. GST)	PROD. CAT.
L-H3016	K80-T9R respirator complete with helmet, blower unit and belt, single filter and 12V cable-charger for connection to a continuous 12V power source such as a tractor or vehicle. This unit will operate for approximately 30 minutes without the 12V power source from a small battery in the blower unit. Optional 240V charger available to charge the battery for 30 minutes of use if required as a stand-alone function. Designed to be continuously powered while in use. Agricultural use only	2,139.00	2,352.90	D
L-H3017A	K80-T5 respirator complete with helmet, blower unit and belt, single filter and lithium battery pack – also carried on the belt. For agricultural use only. Unit not pictured	2,333.00	2,566.30	D

KASCO FILTERS

	DESCRIPTION	CLASS	COLOUR ON CARTRIDGE	PROTECTION AGAINST	\$ (EX. GST)	\$ (INC. GST)	PROD. CAT.
KASCO-0601/19	ZA2P3 Filter	P3R		Particles, liquid and solid aerosols, organic vapours and gases	149.00	163.90	D
KASCO-0601/25	ZA2B2P3 Filter	A2P3R		Particles, liquid and solid aerosols, organic vapours and gases, inorganic vapours and gases. Suitable for HiCane use	165.00	181.50	D

MASKS AND FILTERS

L-H3300	SR100 silicone mask for superior face seal. Double anti-clog exhaust valves, filter not included	167.00	183.70	D
L-H3500	Particle filter P3 (210/310) particles, wet and dry dust, aerosols, mould, bacteria, viruses, smoke, mist and fumes	54.00	59.40	D
L-H3501	Pre-filter 221-1 (pack of 10)	19.00	20.90	D
L-H3502	Gas filter A1 (217) organic vapour such as solvents – regular capacity	69.00	75.90	D
L-H3503	Gas filter A2 (218) organic vapour such as solvents – high capacity	69.00	75.90	D
L-H3505	Gas filter ABEK1 (297) organic vapour such as solvents and inorganic vapour, acid gas and ammonia	81.00	89.10	D

FIRE SAFETY RANGE

FIREFIGHTERS

Don't take risks with your property – gear up for the fire season with a Croplands firefighter in either a truck/traymount or trailed option.



BT1500/FF2

Heavy-duty 1500L trailed firefighter on galvanised chassis – hook up and go at a moment's notice when the need arises



US500/FF1

500L traymount firefighter on galvanised steel skid

SHUMB25LK

MiniBlaze firefighter kit with 2.5HP petrol motor. Quick-fill priming port and 1" discharge. Plus 5m of 20mm hose with nozzle



**SHUB55H
FIREFIGHTER PUMP**

Honda-powered Onga pumps provide effortless starts in all weather and conditions and rapid movement of water volume



FIREFIGHTERS

		\$ (EX. GST)	\$ (INC. GST)	PROD. CAT.
SHUMB25LK	MiniBlaze firefighter kit, 2.5HP petrol motor. Quick-fill priming port, 1" discharge, 5m of 20mm hose with nozzle, 2.5m suction hose with filter. Tool kit supplied. Flow rate 50–150 L/min	1,260.00	1,386.00	B
SHUB55H	Honda GX160-powered Onga firefighter pump. Industrial grade nylon impeller, alloy housing, 3-way discharge outlets and carry handle. 1 1/2" priming port. Flow rate 100–500 L/min in the 2–5 bar pressure range. Price is for pump only	1,720.00	1,892.00	B
US500/FF1	Traymount 500L firefighter. Galvanised frame, SHUB55H pump, heavy-duty steel hose reel with 30m of 20mm delivery hose, adjustable nozzle and 3m suction kit with filter	5,725.00	6,297.50	A
BT1100/FF	Trailed 1100L firefighter with sprung axle, galvanised chassis, eye-hitch, ag-tyres, SHUB55H pump, heavy-duty steel hose reel with 30m of 20mm delivery hose, adjustable nozzle and 3m suction kit with filter. Ideal for farm use (not pictured)	10,573.00	11,630.30	A
BT1500/FF	Trailed 1500L firefighter with sprung axle, galvanised chassis, eye-hitch, ag-tyres, SHUB55H pump, heavy-duty steel hose reel with 30m of 20mm delivery hose, adjustable nozzle and 3m suction kit with filter. Ideal for farm use (not pictured)	11,071.00	12,178.10	A
BT1500/FF2	Pro-series trailed 1500L firefighter with sprung axle, galvanised chassis with mudguards, tow-hitch, brakes, lights, Land Cruiser wheels, SHUB55H pump, heavy-duty steel hose reel with 30m of 20mm delivery hose, adjustable nozzle and 3m suction kit with filter	19,073.00	20,980.30	A

Please note: trailed firefighters are not legal for road use.

SPRAY TANKS



TANKS

	POSITION	LITRE CAPACITY	DIMENSIONS (MM)			STRAINER	FREESTANDING	\$ (EX. GST)	\$ (INC. GST)	PROD. CAT.
			L	W	H					
P20	(not shown)	20	300	300	400	No	No	211.00	232.10	A
P30B	A	30	625	300	333	Yes	Yes	271.00	298.10	A
P60B	B	60	740	380	380	Yes	Yes	335.00	368.50	A
P100	C	100	975	400	425	Yes	Yes	391.00	430.10	A
P200	D	200	900	600	600	Yes	No	445.00	489.50	A
P200B	E	200	1160	580	539	Yes	Yes	913.00	1,004.30	A
P300	F	300	1100	550	550	Yes	No	627.00	689.70	A
P300B	G	300	1269	750	753	Yes	No	964.00	1,060.40	A
P400	H	400	1490	627	760	Yes	Yes	1,457.00	1,602.70	A
P400C	I	400	1190	760	650	Yes	No	668.00	734.80	A
P450	J	450	1070	750	580	Yes	No	777.00	854.70	A
P500C	K	500	1190	760	825	Yes	No	848.00	932.80	A
P700	(not shown)	700	1350	640	1200	Yes	No	1,487.00	1,635.70	A
P800	L	800	1740	1000	770	Yes	Yes	2,268.00	2,494.80	A
P1000L	M	1000	1350	800	1500	Yes	No	1,500.00	1,650.00	A
P1100A	N	1100	1400	1279	890	Yes	Yes	1,700.00	1,870.00	A
P1500A	O	1500	1400	1430	1150	Yes	No	2,100.00	2,310.00	A
P2000	P	2000	2200	1300	1030	Yes	No	1,970.00	2,167.00	A
P3000	Q	3000	2200	1300	1300	Yes	No	2,812.00	3,093.20	A
P4000A	R	4000	2200	1300	1670	Yes	No	3,286.00	3,614.60	A

All tanks are supplied with a lid and outlet. All prices are ex-store. Dimensions may change without notice. Dimensions may vary from tank to tank.

PUMPS

From spot spraying to large-scale broadacre and horticulture application, Croplands has carefully selected a range of pumps that deliver first-class productivity and efficiency.



AR DIAPHRAGM PUMPS

LOW PRESSURE



The Annovi Reverberi (AR) range of reliable and robust diaphragm pumps have been industry leaders for more than 60 years and have partnered with Croplands for more than 40 years.

FOR CONTROLLER OPTIONS SEE PAGE 47

DRIVE OPTIONS

- APCC** Cardan shaft – 1 3/8" 6-spline shaft both sides of pump
- C** Cardan shaft – pump is fitted with a 1 3/8" male 6-spline shaft
- CF25** Female input for direct hydraulic motor fitting
- CF32** 6-spline male shaft on one side
- CR** Gearbox fitted to pump but without PRV fitted
- CRGI** Gearbox and PRV fitted to pump
- SP** Bare shaft – models to suit various kits and applications
- T** Tractor kit – to connect pump directly to tractor PTO shaft

For petrol and electric drive models, see following pages along with spare parts information.



AR80LFP



AR140LFP-C



AR185LFP-CF25



AR252



AR70

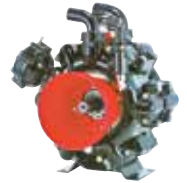

AR250

IDEAL FOR SMALL BOOM SPRAYERS

AR252 - OPEN FLOW: 25 L/MIN

MAX PRESSURE: 25 BAR MAX RPM: 650 WEIGHT: 4KG HP REQUIRED: 1.45
TWIN DIAPHRAGM PUMP \$ (EX. GST) \$ (INC. GST) PROD. CAT.

AR252-C	C	950.00	1,045.00	C
AR252-T	T	1,275.00	1,402.50	C
AR252-SP	SP	893.00	982.30	C
AR252-CRGI	CRGI	1,518.00	1,669.80	C

IDEAL FOR BOOMS UP TO 12 METRES

AR70 - OPEN FLOW: 72 L/MIN

MAX PRESSURE: 20 BAR MAX RPM: 550 WEIGHT: 11.8KG HP REQUIRED: 3.4
TWIN DIAPHRAGM PUMP \$ (EX. GST) \$ (INC. GST) PROD. CAT.

AR70-C	C	1,431.00	1,574.10	C
AR70-T	T	1,711.00	1,882.10	C
AR70-SP	SP	1,361.00	1,497.10	C
AR70-CR	CR	2,175.00	2,392.50	C

AR80LFP - OPEN FLOW: 76 L/MIN

MAX PRESSURE: 20 BAR MAX RPM: 550 WEIGHT: 14KG HP REQUIRED: 3.4
TRIPLE DIAPHRAGM, REINFORCED POLY HEADS & MANIFOLDS \$ (EX. GST) \$ (INC. GST) PROD. CAT.

AR80LFP-C	C	1,440.00	1,584.00	C
------------------	----------	----------	----------	---

IDEAL FOR BOOMS UP TO 15 METRES

AR115 - OPEN FLOW: 114 L/MIN

MAX PRESSURE: 20 BAR MAX RPM: 550 WEIGHT: 15.5KG HP REQUIRED: 5.5
TRIPLE DIAPHRAGM PUMP \$ (EX. GST) \$ (INC. GST) PROD. CAT.

AR115-C	C	1,974.00	2,171.40	C
----------------	----------	----------	----------	---

IDEAL FOR BOOMS UP TO 18 METRES

AR140LFP - OPEN FLOW: 132 L/MIN

MAX PRESSURE: 15 BAR MAX RPM: 550 WEIGHT: 16KG HP REQUIRED: 5.2
TRIPLE DIAPHRAGM, REINFORCED NYLON HEADS & MANIFOLDS \$ (EX. GST) \$ (INC. GST) PROD. CAT.

AR140LFP-C	Available with C	2,177.00	2,394.70	C
-------------------	-------------------------	----------	----------	---

IDEAL FOR BOOMS UP TO 21-24 METRES

AR160LFP - OPEN FLOW: 166 L/MIN

MAX PRESSURE: 15 BAR MAX RPM: 550 WEIGHT: 25KG HP REQUIRED: 6.8
FOUR DIAPHRAGM, REINFORCED NYLON HEADS & MANIFOLDS \$ (EX. GST) \$ (INC. GST) PROD. CAT.

AR160LFP-CF25	Available with CF25	3,234.00	3,557.40	C
----------------------	----------------------------	----------	----------	---

AR185LFP - OPEN FLOW: 182 L/MIN

MAX PRESSURE: 15 BAR MAX RPM: 550 WEIGHT: 25KG HP REQUIRED: 7.4
FOUR DIAPHRAGM, REINFORCED NYLON HEADS & MANIFOLDS \$ (EX. GST) \$ (INC. GST) PROD. CAT.

AR185LFP-CF25	Available with CF25	3,373.00	3,710.30	C
----------------------	----------------------------	----------	----------	---

IDEAL FOR BOOMS UP TO 36 METRES

AR250 - OPEN FLOW: 254 L/MIN

MAX PRESSURE: 20 BAR MAX RPM: 550 WEIGHT: 35.8KG HP REQUIRED: 11.4
SIX DIAPHRAGM PUMP \$ (EX. GST) \$ (INC. GST) PROD. CAT.

AR250-CF25	Available with CF25	4,250.00	4,675.00	C
-------------------	----------------------------	----------	----------	---

MEDIUM & HIGH PRESSURE

Annovi Reverberi (AR) has developed a complete range of diaphragm pumps to suit the changing demands of agriculture.

The heads and manifolds are made from reinforced polypropylene or nylon to allow use with a wider range of products, including liquid fertilisers.

FOR CONTROLLER OPTIONS SEE PAGE 47



AR1604

ARBHS170/ARBHS200

AR813

AR1064

AR30/AR40

AR303

AR503

IDEAL FOR HIGH-PRESSURE SPOT-SPRAYING UNITS & SMALL AIRBLAST SPRAYERS

AR813 - OPEN FLOW: 80 L/MIN

MAX PRESSURE: 50 BAR MAX RPM: 550 WEIGHT: 20.5KG HP REQUIRED: 8.8
 TRIPLE DIAPHRAGM PUMP \$ (EX. GST) \$ (INC. GST) PROD. CAT.

AR813-APCC	Available with APCC	2,309.00	2,539.90	C
AR813-CSP	Available with CSP	2,348.00	2,582.80	C

AR1064 - OPEN FLOW: 105 L/MIN

MAX PRESSURE: 50 BAR MAX RPM: 550 WEIGHT: 23.5KG HP REQUIRED: 13.1
 FOUR DIAPHRAGM PUMP \$ (EX. GST) \$ (INC. GST) PROD. CAT.

AR1064-APCC	Available with APCC	2,571.00	2,828.10	C
-------------	---------------------	----------	----------	---

IDEAL FOR HIGH-PRESSURE AIRBLAST SPRAYERS

AR1604 - OPEN FLOW: 153 L/MIN

MAX PRESSURE: 50 BAR MAX RPM: 550 WEIGHT: 40KG HP REQUIRED: 18
 FOUR DIAPHRAGM PUMP \$ (EX. GST) \$ (INC. GST) PROD. CAT.

AR1604-APCC	Available with APCC	3,798.00	4,177.80	C
-------------	---------------------	----------	----------	---

ARBHS170 - OPEN FLOW: 163 L/MIN

MAX PRESSURE: 50 BAR MAX RPM: 550 WEIGHT: 65KG HP REQUIRED: 19.3
 FOUR DIAPHRAGM PUMP \$ (EX. GST) \$ (INC. GST) PROD. CAT.

ARBHS170-APCC	Available with APCC	5,995.00	6,594.50	C
---------------	---------------------	----------	----------	---

ARBHS200 - OPEN FLOW: 194 L/MIN

MAX PRESSURE: 50 BAR MAX RPM: 550 WEIGHT: 65KG HP REQUIRED: 22.1
 FOUR DIAPHRAGM PUMP \$ (EX. GST) \$ (INC. GST) PROD. CAT.

ARBHS200-APCC	Available with APCC	6,462.00	7,108.20	C
---------------	---------------------	----------	----------	---

IDEAL FOR SPOT-SPRAYING UNITS

AR30 - OPEN FLOW: 35 L/MIN

MAX PRESSURE: 40 BAR MAX RPM: 550 WEIGHT: 9.3KG HP REQUIRED: 2.9
 TWIN DIAPHRAGM PUMP \$ (EX. GST) \$ (INC. GST) PROD. CAT.

AR30-C	Available with C	1,351.00	1,486.10	C
AR30-T	Available with SP	1,626.00	1,788.60	C
AR30-SP	Available with T	1,267.00	1,393.70	C
AR30-CRGI	Available with CRGI	2,117.00	2,328.70	C

AR40 - OPEN FLOW: 46.3 L/MIN

MAX PRESSURE: 40 BAR MAX RPM: 550 WEIGHT: 9.5KG HP REQUIRED: 3.5
 TWIN DIAPHRAGM PUMP \$ (EX. GST) \$ (INC. GST) PROD. CAT.

AR40-CRGI	Available with CRGI	2,160.00	2,376.00	C
-----------	---------------------	----------	----------	---

AR303 - OPEN FLOW: 35 L/MIN

MAX PRESSURE: 40 BAR MAX RPM: 550 WEIGHT: 9KG HP REQUIRED: 3
 TRIPLE DIAPHRAGM PUMP \$ (EX. GST) \$ (INC. GST) PROD. CAT.

AR303-CR	Available with CR	1,906.00	2,096.60	C
----------	-------------------	----------	----------	---

AR503 - OPEN FLOW: 54 L/MIN

MAX PRESSURE: 40 BAR MAX RPM: 550 WEIGHT: 11.5KG HP REQUIRED: 5.6
 TRIPLE DIAPHRAGM PUMP \$ (EX. GST) \$ (INC. GST) PROD. CAT.

AR503-T	Available with T	1,864.00	2,050.40	C
AR503-SP	Available with SP	1,462.00	1,608.20	C
AR503-CR	Available with CR	1,850.00	2,035.00	C
AR503-CRGI	Available with CRGI	2,701.00	2,971.10	C

Note: All flow information is at zero pressure, open flow.

AR MOTORISED PUMPS

PETROL & ELECTRIC DRIVE

Croplands have a great range of petrol and electric-drive pumps for spraying and semi-industrial applications.

Powered by genuine Honda engines, the petrol-powered models are bulletproof and will run day in, day out.

POWERED by HONDA™

DRIVE OPTIONS

GX GX200QX Engine	EM Single phase electric motor
AR-ES Electric start kit of Honda motor	ET Three phase electric motor



AR70

AR135

AR252

IDEAL FOR SMALL BOOM SPRAYERS

AR252 - OPEN FLOW: 25 L/MIN
MAX PRESSURE: 25 BAR MAX RPM: 650 WEIGHT: 4KG HP REQUIRED: 1.45

TWIN DIAPHRAGM PUMP		\$ (EX. GST)	\$ (INC. GST)	PROD. CAT.
AR252-4H	Available with	GX 2,635.00	2,898.50	C
AR252-EM		EM 1,981.00	2,179.10	C

IDEAL FOR BOOMS UP TO 12 METRES

AR70 - OPEN FLOW: 72 L/MIN
MAX PRESSURE: 20 BAR MAX RPM: 550 WEIGHT: 11.8KG HP REQUIRED: 3.4
TWIN DIAPHRAGM PUMP

		\$ (EX. GST)	\$ (INC. GST)	PROD. CAT.
AR70-5H	Available with GX	4,174.00	4,591.40	C

IDEAL FOR SPOT-SPRAYING UNITS

AR30
 (SEE PREVIOUS PAGE FOR SPECS & VISUAL)

		\$ (EX. GST)	\$ (INC. GST)	PROD. CAT.
AR30-5H	Available with	GX 3,460.00	3,806.00	C
AR30-EM		EM 3,974.00	4,371.40	C
AR30-ET		ET 3,731.00	4,104.10	C

IDEAL FOR BOOMS UP TO 18 METRES

AR135 - OPEN FLOW: 132 L/MIN
MAX PRESSURE: 20 BAR MAX RPM: 550 WEIGHT: 15.5KG HP REQUIRED: 6.8
TRIPLE DIAPHRAGM PUMP

		\$ (EX. GST)	\$ (INC. GST)	PROD. CAT.
AR135-6.5H	Available with GX	4,989.00	5,487.90	C

AR40
 (SEE PREVIOUS PAGE FOR SPECS & VISUAL)

		\$ (EX. GST)	\$ (INC. GST)	PROD. CAT.
AR40-6H	Available with GX	3,563.00	3,919.30	C

AR303
 (SEE PREVIOUS PAGE FOR SPECS & VISUAL)

		\$ (EX. GST)	\$ (INC. GST)	PROD. CAT.
AR303-6H	Available with GX	3,268.00	3,594.80	C

TO PETROL DRIVE LARGER AR PUMPS, PLEASE CONTACT CROPLANDS FOR OPTIONS AND PRICING.

NOTE, TO FIT ELECTRIC START ON THE AR PETROL-DRIVEN MOTORISED PUMPS ON THIS PAGE, PLEASE ADD THE FOLLOWING CODE AND PRICE TO YOUR ORDER (AR-ES).



AR252-4H



AR252-EM



AR303-6H

PARTS & ACCESSORIES



AR550086



AR759051



AR110121



AR1434



GEARBOX FITTED

DIAPHRAGMS FOR PUMP MODELS

		MATERIAL	\$ (EX. GST)	\$ (INC. GST)	PROD. CAT.
AR1040080	AR80LFP-C	DESMOPAN	42.00	46.20	C
AR550086	AR70, 115, 125, 135, 145, 160, 185, 250, 280, 370, 500 (20 bar max), AR140FLP-C	HPDS	64.00	70.40	C
AR620080	AR30 (40 bar max), AR503 (50 bar max)	GOMMA	40.00	44.00	C
AR800086	AR19 and 252 (20 bar max)	HPDS	40.00	44.00	C
AR1040081	AR813, 1064 (50 bar max), AR80LFP-C	GOMMA	44.00	48.40	C
AR2240080	ARBHA140, BHS140, BHS160/170, BHS200 (50 bar max)	GOMMA	58.00	63.80	C

VALVES FOR PUMP MODELS

AR759051	AR70, 115, 125, 135, 145, 160, 185, 250, 280, 370, 500 (20 bar max). ARBHA140, BHS140, BHS160/170, AR2HS200 (50 bar max)		64.00	70.40	C
AR1409050	AR30 (40 bar max). AR503, 813, 1064 (50 bar max)		45.00	49.50	C
AR809060	AR252 (25 bar max)		28.00	30.80	C
AR2429050	AR80LFP-C, AR140FLP-C		79.00	86.90	C

VALVE O-RINGS FOR PUMP MODELS

AR680070	AR125, 145, 160, 185, 250, 280, 370, 500 (20 bar max). ARBHA140, BHS140, BHS160/170, BHS200 (50 bar max)		3.50	3.85	C
AR320030	AR70, 115, 135 (20 bar max)		3.50	3.85	C
AR620030	AR30 (40 bar max). AR503, 813, 1064 (50 bar max)		2.00	2.20	C
AR880830	AR252 (25 bar max)		1.00	1.10	C
AR3460240	AR80LFP-C, AR140FLP-C		16.00	17.60	C

DISC FOR ARG140 REGULATOR

AR110121	Vulkulan disc		15.00	16.50	C
AR1922	5 pack of Vulkulan discs		63.00	69.30	C

COMMON REPAIR KITS

PR66	2 X AR550086 for AR70 pump		90.00	99.00	C
PR67	4 valves and O-rings for AR70		171.00	188.10	C
AR2374	Kit (8 x 680070 and 8 x 759051) for 4-diaphragm pumps		486.00	534.60	C
AR1917	Valve and O-rings kit for AR30		157.00	172.70	C
AR1925	Kit reg overhaul (GI40) for ARG140 regulator		81.00	89.10	C

SAFETY RELIEF VALVES

AR1432	Valve safety (20 bar) – safety relief valve with reset		78.00	85.80	C
AR1433	Valve safety (40 bar) – safety relief valve with reset		80.00	88.00	C
AR1434	Valve safety (50 bar) – safety relief valve with reset		82.00	90.20	C

COMMONLY USED GEARBOXES FOR AR PUMPS

AR1613	Gearbox (AR19/202/252 1:4.3)		627.00	689.70	C
AR1636	Gearbox (AR30 1:5.9)		1,135.00	1,248.50	C
AR1639	Gearbox (AR50/503/703/904 1:5.9)		1,177.00	1,294.70	C
AR1671	Gearbox (AR70/115/120 1:5.9)		1,393.00	1,532.30	C

MANUAL CONTROL VALVE AND REGULATOR

PARTS & ACCESSORIES



ARBMH50



ARECM-4



ARUCM-5



ARIDROM-4

CONTROLLERS

		\$ (EX. GST)	\$ (INC. GST)	PROD. CAT.
ARGR30	Controller for AR252 pump, max flow 40 L/min, maximum operating pressure 25 bar (360 psi) Mounting kit not included (*see AR892 for remote mount kit)	162.00	178.20	C
ARGI40	3-outlet (2-taps supplied) manual controller suited to the AR30 pump. Can be pump mounted or remote mounted* (*see AR980 for remote mount kit). Max flow 80 L/min, maximum pressure 40 bar (580 psi)	270.00	297.00	C
ARRM40I	Two-way controller to suit AR503 pump. Can be pump mounted or remote mounted* (*see AR985 for remote mount kit). Max flow 90 L/min, maximum pressure 40 bar (580 psi)	304.00	334.40	C
ARVDR50	Two-way controller to suit AR813 or AR1064 pump. Can be pump mounted or remote mounted* (*see AR998 for remote mount kit). Max flow 130 L/min, maximum pressure 50 bar (725 psi)	526.00	578.60	C
ARBMH50	Two-outlet manual controller suited to high-pressure 50 bar-rated diaphragm pumps. Rotary selector lever controls individual left and right shut-off or master shut-off with either pressure bypass or non-pressure bypass. Can be pump mounted or remote mounted* (*see AR996 for remote mount kit). Max flow 200 L/min, maximum pressure 50 bar (725 psi)	702.00	772.20	C
ARECM-4	Remote mount 4-way controller suitable for most 20 bar-rated diaphragm pumps. 4 individual shut-off taps and gauge fitted. Comes with remote-mount plate fitted. Max flow 150 L/min, maximum pressure 20 bar (290 psi). 2-tap version also available	466.00	512.60	C
ARUCM-5	Remote mount 5-way controller suitable for most 20 bar-rated diaphragm pumps. 5 individual shut-off taps, master shut-off lever and gauge fitted. Comes with remote-mount plate fitted. Max flow 150 L/min, maximum pressure 20 bar (290 psi). 2-tap and 6-tap version also available. Fitted as standard on all AgriPak linkages	809.00	889.90	C
ARIDROM-4	Remote-mount pressure compensating 4-way controller suitable for most 20 bar-rated diaphragm pumps. Bypass taps on each section can be adjusted for pressure compensation of +/- 15%. 4 individual shut-off taps, master shut-off lever and gauge fitted. Comes with remote-mount plate fitted. Max flow 150 L/min, maximum pressure 20 bar (290 psi). 2-tap and 6-tap version also available	1,099.00	1,208.90	C



ARGR30/AR892



ARGI40/AR980



ARRM40I/AR985



ARVDR50/AR998

REMOTE MOUNT KITS

		\$ (EX. GST)	\$ (INC. GST)	PROD. CAT.
AR892	Suits ARGR30, includes mount plate and bolts, extra tap, hoesetails and inlet/outlet fitting	122.00	134.20	C
AR980	Suits ARGI40, includes mount plate and bolts, extra tap, hoesetail and inlet/outlet fitting	138.00	151.80	C
AR985	Suits ARRM40I, includes mount plate and bolts, extra tap, hoesetails and inlet/outlet fitting	138.00	151.80	C
AR998	Suits ARVDR50, includes mount plate and bolts, extra tap, hoesetails and inlet/outlet fitting	176.00	193.60	C
AR996	Suits ARBMH50, includes mount plate and bolts, hoesetails and inlet/outlet fitting	66.00	72.60	C

CENTRIFUGAL MODELS



Hypro centrifugal pumps, made from cast iron or stainless steel housings for exceptional pump performance. Life Guard seals optional on select pumps give longer-lasting seal life.



9203C-B



9303C-HM1C-B



9303C-HM5C-B

	SPECIFICATIONS	OUTPUT & INPUT	\$ (EX. GST)	\$ (INC. GST)	PROD. CAT.	
9203C-B	<ul style="list-style-type: none"> 9203C series pedestal-mount centrifugal pump Cast-iron housing with nylon impeller Shaft rotation: counter clockwise when looking at the shaft-end 	Port sizes: 1-1/2" NPT inlet; 1-1/4" NPT outlet Input shaft size: 5/8" (15.9mm) solid shaft Weight: 8.6kg Fitted to a number of OEM sprayers	Max fluid temp: 60° C Max pressure: 11.7 bar (170 psi) Max L/min flow: 530 Max RPM: 6000 435 L/min flow at 2.8 bar pressure and 4200 RPM	1,399.00	1,538.90	B
9303C-HM1C-B	<ul style="list-style-type: none"> 9303C series pedestal-mount centrifugal pump with hydraulic motor fitted (for open centre, closed centre and load-sensing systems) Cast-iron housing with nylon impeller 	Liquid Port sizes: 1-1/2" NPT inlet; 1-1/4" NPT outlet Hydraulic motor: internal gear gerotor; max motor psi = 3000 Hydraulic ports: 1/2" NPT inlet, 3/4" NPT outlet Hydraulic motor seal: double-lip Teflon Weight: 11.8kg Fitted to a number of OEM sprayers Fitted standard to Croplands 4000 and 6000L WEED-IT sprayers	Max fluid temp: 60° C Max pressure: 9 bar (130 psi) Max L/min flow: 432 Max hyd flow required: 49.2 L/min 397 L/min flow at 3.4 bar pressure and 45.4 L/min hydraulic flow	2,800.00	3,080.00	B
9303C-HM5C-B	<ul style="list-style-type: none"> 9303C series pedestal-mount centrifugal pump with hydraulic motor fitted (for open centre, closed centre and load-sensing systems) Cast-iron housing with nylon impeller 	Liquid port sizes: 1-1/2" NPT inlet; 1-1/4" NPT outlet Hydraulic motor: internal gear gerotor; max motor psi = 3000 Hydraulic ports: 1/2" NPT inlet, 3/4" NPT outlet Hydraulic motor seal: double-lip Teflon Weight: 11.8kg Fitted to a number of OEM sprayers	Max fluid temp: 60° C Max pressure: 10 bar (145 psi) Max L/min flow: 556 Max hyd flow required: 60.6 L/min 450 L/min flow at 4.1 bar pressure and 56.8 L/min hydraulic flow	2,956.00	3,251.60	B



9306C-HM5C-B



9306C-HM5C-3U



9306S-HM5C-3U

	SPECIFICATIONS	OUTPUT & INPUT	\$(EX. GST)	\$(INC. GST)	PROD.CAT.	
9306C-HM5C-B	<ul style="list-style-type: none"> 9306C series pedestal-mount centrifugal pump with hydraulic motor fitted (for open centre, closed centre and load-sensing systems) Cast-iron housing with nylon impeller 	Liquid port sizes: 2" NPT Inlet; 1-½" NPT outlet Hydraulic motor: internal gear gerotor; max motor psi = 3000 Hydraulic ports: ½" NPT inlet, ¾" NPT outlet Hydraulic motor seal: double-lip Teflon Weight: 15kg Fitted to a number of OEM sprayers Suits RG series RoGator sprayer models – replaces part number AC579304D1	Max fluid temp: 60° C Max pressure: 9.6 bar (140 psi) Max L/min flow: 803 Max hyd flow required: 64.4 L/min 803 L/min flow at 4.1 bar pressure and 60.6 L/min hydraulic flow Internal threaded	3,249.00	3,573.90	B
9306C-HM5C-3U	<ul style="list-style-type: none"> 9306C series centrifugal pump with hydraulic motor fitted (for open centre, closed centre and load-sensing systems) Cast-iron housing with nylon impeller 	Liquid port sizes: 300 x 220 (3U) universal flange Hydraulic motor: internal gear gerotor; max motor psi = 3000 Hydraulic ports: ½" NPT inlet, ¾" NPT outlet Hydraulic motor seal: double-lip Teflon Weight: 15kg Fitted to a number of OEM sprayers	Max fluid temp: 60° C Max pressure: 9.6 bar (140 psi) Max L/min flow: 1181 Max hyd flow required: 64.4 L/min 1018 L/min flow at 3.4 bar pressure and 60.6 L/min hydraulic flow	3,271.00	3,598.10	B
9306S-HM5C-3U	<ul style="list-style-type: none"> 9306S series pedestal-mount stainless-steel centrifugal pump with hydraulic motor fitted (for open centre, closed centre and load-sensing systems) Stainless-steel housing with polypropylene impeller 	Liquid port sizes: 2" NPT Inlet; 1-½" NPT outlet Hydraulic motor: internal gear gerotor; max motor psi = 3000 Hydraulic ports: ½" NPT inlet, ¾" NPT outlet Hydraulic motor seal: double-lip Teflon Weight: 15kg Fitted to a number of OEM sprayers Optional stainless-steel pump for Croplands WEED-IT 7000L sprayer (replaces cast iron 9306C-HM5C-BU – 2 pumps fitted standard) Suits RG series RoGator sprayer models as a stainless-steel option – replaces part number AC579304D1	Max fluid temp: 60° C Max pressure: 9.6 bar (140 psi) Max L/min flow: 803 Max hyd flow required: 64.4 L/min 803 L/min flow at 4.1 bar pressure and 60.6 L/min hydraulic flow	5,740.00	6,314.00	B



9342P-HM5C-5SP



9343P-GM6-SP

POLY TRANSFER PUMPS

	SPECIFICATIONS	OUTPUT & INPUT	\$(EX. GST)	\$(INC. GST)	PROD. CAT.	
9342P-HM5C-5SP	<ul style="list-style-type: none"> Poly transfer pump, 2" with hydraulic motor drive Polypropylene housing Suction lift 7.62m 5-vane impeller 2" NPT inlet and 2" NPT outlet ports 	Hydraulic ports: ½" NPT inlet, ¾" NPT outlet Optional for Croplands 4000 and 6000L WEED-IT sprayers as a filling pump	Max pressure: 4 bar (58 psi) Max L/min flow: 757 Max hyd flow required: 42 L/min	2,499.00	2,748.90	B
9343P-GM6-SP	<ul style="list-style-type: none"> Poly transfer pump, 3" with hydraulic motor drive Polypropylene housing Suction lift 7.62m Poly impeller with stainless-steel insert 3" NPT inlet and 3" NPT outlet ports 	Hydraulic ports: ½" NPT inlet, ¾" NPT outlet Optional for Croplands RoGator sprayers as a filling pump	Max pressure: 3 bar (44 psi) Max L/min flow: 1730 Max hyd flow required: 60 L/min	3,200.00	3,520.00	B

SHURFLO

PUMPS & ACCESSORIES

SHURflo

SHURflo 12V pumps are ideal for spot spraying and small, multi-tip boom sprayers mounted on RTVs, ATVs, ute trays or small trailed sprayers.



SHU8000-547-189



SHU2088-313-544



SHU50593611D011



SHU255-613

			\$ (EX. GST)	\$ (INC. GST)	PROD. CAT.
SHU8000-547-189 (PUMP)	<ul style="list-style-type: none"> • SHURflo 12V DC bypass diaphragm pump • Santoprene diaphragm; Viton valves • 12V sealed motor • Self-priming to 2.4m • Proven pump head design • Internal bypass for smooth flow operation • Ag-chemical resistant materials 	Max L/min (open flow): 6.8 Max pressure: psi: 107 bar: 7.4 Port size: ½"m Max amps: 7.3 Pressure Switch: yes Internal Bypass: yes	250.00	275.00	B
SHU94-385-32	DIAPHRAGM/DRIVE ASSEMBLY KIT	To suit pump model SHU8000-547-189	165.00	181.50	B
SHU94-391-46	VALVE ASSEMBLY KIT	To suit pump model SHU8000-547-189	144.00	158.40	B
SHU94-229-08	PRESSURE SWITCH KIT	To suit pump model SHU8000-547-189	86.00	94.60	B
SHU94-374-08	CHECK VALVE KIT	To suit pump model SHU8000-547-189	44.00	48.40	B
SHU2088-313-544 (PUMP)	<ul style="list-style-type: none"> • SHURflo 12V DC bypass diaphragm pump • Santoprene diaphragm; Viton valves • 12V sealed motor • Self-priming to 2.4m • Proven pump head design • Internal bypass for smooth flow operation • Ag-chemical resistant materials 	Max L/min (open flow): 15.1 Max pressure: psi 45 bar: 3.1 Port size: ½"m Max amps: 13 Pressure Switch: yes Internal Bypass: yes	559.00	614.90	B
SHU50593611D011 (PUMP)	<ul style="list-style-type: none"> • SHURflo 12V DC bypass diaphragm pump • Santoprene diaphragm; Viton valves • 12V sealed motor • Self-priming to 2.4m • Proven pump head design • Internal bypass for smooth flow-operation 	Max L/min (open flow): 20.1 Max pressure: psi: 90 bar: 6.2 Port size: ½"m Max amps: 20.9 Pressure switch: no Internal bypass: yes	569.00	625.90	B
SHU94-910-04	DIAPHRAGM/DRIVE ASSEMBLY KIT	To suit pump model SHU5059-1311-D011	244.00	268.40	B
SHU94-910-05	VALVE ASSEMBLY KIT	To suit pump model SHU5059-1311-D011	163.00	179.30	B
SHU94-910-02	PRESSURE SWITCH KIT	To suit pump model SHU5059-1311-D011	59.00	64.90	B
SHU94-910-03	CHECK VALVE KIT	To suit pump model SHU5059-1311-D011	45.00	49.50	B

HOSE FITTINGS

		\$ (EX. GST)	\$ (INC. GST)	PROD. CAT.
SHU234-2926	½" NPT – 14 female x 12mm (½") straight swivel barb (polypropylene)	3.50	3.85	B
SHU234-2916	½" NPT – 14 female x 10mm (¾") straight swivel barb (polypropylene)	3.50	3.85	B
SHU234-3926	½" NPT – 14 female x 12mm (½") elbow swivel barb (polypropylene)	3.50	3.85	B
SHU234-3916	½" NPT – 14 female x 10mm (¾") elbow swivel barb (polypropylene)	3.50	3.85	B

FLOJET

PUMPS & ACCESSORIES

FLOJET®

The FloJet range of 12V pumps is designed for small spot spraying and boom spraying operations. FloJet pumps perform well if used correctly and flushed out after use.



FL3501-506



FL20419-012



FL02091-060



FL20407-033

3501 TRIPLEX PUMP

			\$ (EX. GST)	\$ (INC. GST)	PROD. CAT.
FL3501-506	<ul style="list-style-type: none"> Fully sealed motor for corrosion resistance Pressure switch for spot spraying and an internal bypass to ensure pump does not pulsate with small nozzle sizes Low pulsation and noise Superior pump head sealing Excellent priming Compact size 3/8" threaded ports for use with hoesetails or threaded nipples Ideal for small boom or spot spraying and some other agricultural uses 	With press. switch: Yes Max L/min (open flow): 7.8 Volts: 12V DC Max press. (bar): 3.4 Inlet and outlet: 3/8" hosebarb Internal bypass: Yes Diaphragm material: S Valve material: S Amps: 8	372.00	409.20	B
FL20419-012	DIAPHRAGM	To suit pump model FL3501-506	130.00	143.00	B
FL02091-060	PRESSURE SWITCH	To suit pump model FL3501-506	129.00	141.90	B
FL20407-033	VALVE	To suit pump model FL3501-506	98.00	107.80	B



FL3521-139



FL20419-015



FL02091-060



FL20407-021

3521 TRIPLEX PUMP

			\$ (EX. GST)	\$ (INC. GST)	PROD. CAT.
FL3521-139	<ul style="list-style-type: none"> Maximum flow of 15.1 L/min (open-flow) Internal bypass gives this model superior, smooth liquid delivery for multiple nozzles Plug-in bayonet connections (1/2") with quick release clips Suited for small booms and high volume spot spraying. Triplex design makes it an excellent priming option 	With press. switch: Yes Max L/min (open flow): 15.1 Volts: 12V DC Max press. (bar): 4 Inlet and outlet: Plug-in bayonet and 1/2" hosebarb Internal bypass: Yes Diaphragm material: S Valve material: V Amps: 9	501.00	551.10	B
FL20419-015	DIAPHRAGM	To suit pump model FL3521-139	164.00	180.40	B
FL02091-060	PRESSURE SWITCH	To suit pump model FL3521-139	129.00	141.90	B
FL20407-021	VALVE	To suit pump model FL3521-139	98.00	107.80	B

ELECTRIC CONTROL KITS

If you need to upgrade your sprayer to control your boom or air-assisted sprayer, Croplands has the right range of electric controls to suit all applications.

FITTED AS OPTIONS TO LINKAGE SPRAYERS SEE PAGE 4

TO SUIT LINKAGE AND BOOM SPRAYERS; LOW-PRESSURE AIR SPRAYERS. ARAG AVAILABLE ON REQUEST.



I-E2012



I-E2032

ELECTRIC CONTROL KITS UP TO 20 BAR PRESSURE

		\$ (EX. GST)	\$ (INC. GST)	PROD. CAT.
I-E2012	Entry-level electric in-cab control with switchbox. One electric on/off valve shuts off the complete boom from the cab. 3 manual taps on the control manifold can be used for each boom section. A manual pressure regulator with gauge is supplied to allow working pressure to be set for the system	937.00	1,030.70	B
I-E2032	Electric in-cab controller with switchbox. 3-section electric valves for individual section shut off, electric pressure regulating valve and a master on/off can all be operated from the switchbox in the cab or vehicle. Requires a reliable 12V power supply	2,429.00	2,671.90	B
I-E2052	- As above for 5-section control	2,826.00	3,108.60	B

TO SUIT HIGH-PRESSURE ORCHARD SPRAYERS

ELECTRIC CONTROL KITS UP TO 40 BAR PRESSURE



I-S4021

		\$ (EX. GST)	\$ (INC. GST)	PROD. CAT.
I-S4020	Electric in-cab controller with switchbox. 2-section high-pressure electric valves for individual left/right shut off can be operated from the switchbox in the cab. Requires a reliable 12V power supply	1,991.00	2,190.10	B
I-S4021	Electric in-cab controller with switchbox. 2-section high-pressure electric valves for individual left/right shut off, electric pressure regulating valve and a master on/off can all be operated from the switchbox in the cab or vehicle. Requires a reliable 12V power supply	3,614.00	3,975.40	B

APPLICATION SPRAY MONITORS

Giving you visibility and accessibility of your spraying operations.



A4670610-HA



A4670610-SR100

SPRAY MONITORS

		\$ (EX. GST)	\$ (INC. GST)	PROD. CAT.
A4670610-HA	The Visio Hectare meter is a handy viewer to hook up to a vehicle or tractor to measure area, distance and speed. Supplied in the kit is the Visio multi-function display, mounting bracket and a speed-sensor that will need to be mounted to read the rotation of a wheel or PTO shaft	1,416.00	1,557.60	B
A4670610-SR100	The Visio spray monitor comes in a kit to fit-up to a boom or orchard sprayer to measure spray application rate, litres used, area, distance and speed. Supplied in the kit is the Visio multi-function display, mounting bracket, speed-sensor that will need to be mounted to read the rotation of a wheel or PTO shaft, a 5–100 L/min flowmeter and all necessary cables. The kit will require some extra fittings to fit to an existing sprayer – consult your Croplands dealer or service agent	2,509.00	2,759.90	B
A4670610-SR200	- As above, but with a higher flow-rated flowmeter (10–200 L/min)	2,509.00	2,759.90	B

APPLICATION

AUTO SPRAY-RATE CONTROLLERS

Total command is at your fingertips with our selection of spray monitors and rate controllers, all designed to give you visibility and accessibility over your spraying operation.



BRAVO180-ARAG3



BA5000-GEO3



HV2400-BRAG2

AUTO SPRAY-RATE CONTROLLERS

		\$ (EX. GST)	\$ (INC. GST)	PROD. CAT.
BA5000-GEO3	<p>Croplands fully auto spray-rate controller for use on linkage sprayers. Optional as a fit-up to any new Croplands sprayer or as an upgrade to an existing sprayer. Features include display of two functions on screen, large back-lit display, heavy-duty switches, up to 10 pre-set application rates, fully programmable and alarm settings and integrated diagnostics. Kit includes: spray manifold with flowmeter, 3-section valve bank, looms, mount and operating instructions. The kit will require some extra fittings to fit to an existing sprayer – consult your Croplands dealer or service agent</p> <p>Note: if you require a kit for a trailed broadacre sprayer, contact Croplands to ensure the correct length looms are supplied</p>	5,113.00	5,624.30	A
BA5000-GEO5	<p>- As above, but with 5 sections</p> <p>Note: if you require a kit for a trailed broadacre sprayer, contact Croplands to ensure the correct length looms are supplied</p>	5,843.00	6,427.30	A
HV2400-BRAG2	<p>Croplands fully auto spray-rate controller for use on horticultural sprayers. Has the same features as the BA5000 (specifications listed above) with the added option on L/100m for application. Kit includes: spray manifold with flowmeter, 2-section high-pressure valve bank, looms, mount and operating instructions. The kit will require some extra fittings to fit to an existing sprayer – consult your Croplands dealer or service agent</p>	7,070.00	7,777.00	A
HV2400-BRAG4	<p>- As above for horticulture, but with 4 high-pressure section valves</p>	7,743.00	8,517.30	A
BRAVO180-ARAG3	<p>ARAG Bravo180S fully auto spray-rate controller for use on linkage sprayers. Optional as a fit-up to any new Croplands sprayer or as an upgrade to an existing sprayer. Features include display of two functions on screen, large back-lit display, heavy-duty switches, up to 10 pre-set application rates, fully programmable, visual and sound alarm settings, programmable units of measure and GPS input for speed. Kit includes: spray manifold with flowmeter, 3-section valve bank, looms, mount and operating instructions. The kit will require some extra fittings to fit to an existing sprayer – consult your Croplands dealer or service agent</p> <p>Note: if you require a kit for a trailed broadacre sprayer, contact Croplands to ensure the correct length looms are supplied</p>	7,735.00	8,508.50	A
BRAVO180-ARAG5	<p>- As above with a 5-section valve bank</p>	8,180.00	8,998.00	A

MANIFOLDS, SWITCHBOXES & COMPONENTS



VALVES, FILTERS & FLOWMETERS TO REPAIR YOUR CONTROL MANIFOLD		MAX PRESS	MAX FLOW	PORTS/BYPASS	\$ (EX. GST)	\$ (INC. GST)	PROD. CAT.
1. A8710502	Dump valve/PRV/inlet assembly	20 bar	180 L/min	32mm	585.00	643.50	B
2. A8630024S	Electric bypass valve, 7 second open/close	20 bar	150 L/min	25mm	447.00	491.70	B
3. A32621135	80-mesh flushing filter with manifold flanges	20 bar	150 L/min	40mm	118.00	129.80	B
4. A46264A0	Wolf Flow Meter 10/200L	20 bar	200 L/min	-	772.00	849.20	B
5. A8730001	Dump valve, hi-flow, 0.6 sec	20 bar	120 L/min	32mm	367.00	403.70	B
6. A8730020S	Electric bypass valve, hi-flow, 7 second open/close	20 bar	150 L/min	25mm	500.00	550.00	B
7. A465522	Manual PRV	20 bar	200 L/min	32mm	197.00	216.70	B
8. A4626000.504	Sensor for Wolf Paddle Flow Meter	-	-	-	460.00	506.00	B
9. A4626000.503	Paddle assembly for Wolf Flow Meter	-	-	-	261.00	287.10	B
UP-402	Proximity sensor BA and HV4000	-	-	-	262.00	288.20	B

ELECTRIC CONTROL MANIFOLDS AND SWITCHBOXES

		\$ (EX. GST)	\$ (INC. GST)	PROD. CAT.
A871CCRO05	Control manifold for auto-rate controllers, for pumps up to 180 L/min, manual PRV, electric bypass (7 sec), dump valve, 80-mesh flushing filter, ARAG Wolf flowmeter, mounting brackets (boom shut-off valves not included)	1,743.00	1,917.30	B
A873CCRO02	Control manifold for auto-rate controllers, for pumps up to 280 L/min, manual PRV, electric bypass (7 sec), dump valve, 80-mesh flushing filter, ARAG Wolf flowmeter, mounting brackets (boom shut-off valves not included)	1,660.00	1,826.00	B
A4628707	Highly accurate programmable flowmeter with LCD display and sapphire bearing paddle turbine. 40–800 L/min reading of actual flow, or you can view litres pumped. 2 separately resettable counters. 2 x AA batteries required. Will require T7 male fittings (A249177)	1,542.00	1,696.20	B



VALVES, FILTERS & FLOWMETERS TO REPAIR YOUR CONTROL MANIFOLD		\$ (EX. GST)	\$ (INC. GST)	PROD. CAT.
10. G8370015	Manual main valve 3 wire	440.00	484.00	B
11. G8386006	Servo valve (7 section)	417.00	458.70	B
12. G8386004	Electric bypass valve, 28 second open/close	417.00	458.70	B
13. GS02000020	Flow sensor square wave	237.00	260.70	B
14. G8404055	Flow meter 10-160	869.00	955.90	B

ELECTRIC CONTROL MANIFOLDS & SWITCHBOXES

		\$ (EX. GST)	\$ (INC. GST)	PROD. CAT.
G8380C0002	Control manifold for auto-rate controllers, for pumps up to 180 L/min, manual PRV, electric by pass (7 section), dump valve, 80-mesh flushing filter, Geoline flowmeter, mounting brackets. (Boom shut off valves not included)	1,799.00	1,978.90	B
G8376088	Control manifold for basic electric control systems. Max flow 180 L/min, 20-bar rated. Kit includes manual PRV, regulating valve, dump valve, pressure filter and 3 proportional electric boom shut-off valves	1,733.00	1,906.30	B
G8376077	Control manifold for basic electric control systems. Max flow 180 L/min, 20-bar rated. Kit includes manual PRV, regulating valve, dump valve, pressure filter and 5 proportional electric boom shut-off valves	2,087.00	2,295.70	B
G8406008	3-section electric switch box and tractor cables. Requires GC00900009 valve cable to connect control manifold. Suitable for G8376088 control manifold	527.00	579.70	B
GC00900009	3-section 5m valve cable. Requires G8406008 electric switch box. Suitable for G8376088 control manifold	250.00	275.00	B
G8406010	5-section electric switch box and tractor cables. Requires GC00900011 valve cable to connect control manifold. Suitable for G8376077 control manifold	573.00	630.30	B
GC00900011	5-section 5m valve cable. Requires G8406010 electric switch box. Suitable for G8376077 control manifold	294.00	323.40	B

ELECTRIC & MANUAL

VALVE KITS



If you are updating your spraying control system, Croplands has a wide range of valves and valve kits to suit your application.

ELECTRIC AND MANUAL VALVES

		\$ (EX. GST)	\$ (INC. GST)	PROD. CAT.
A8630011	Single electric boom shut-off valve, 3-wire for use with auto-rate controllers or basic electric controls, with bypass (suitable for 2 and 3-wire applications)	396.00	435.60	B
A8630001	Single electric boom shut-off valve, 3-wire for use with auto-rate controllers or basic electric controls (suitable for 2 and 3-wire applications)	367.00	403.70	B
A8730001	Electric boom shut-off valve, high flow (120 L/min), 3-wire for use with auto-rate controllers	367.00	403.70	B
A863CCRO05	Electric valve bank, 3-section complete with flushing tap, gauge port and mounting brackets	1,743.00	1,917.30	B
A863CCRO06	Electric valve bank, 5-section complete with flushing tap, gauge port and mounting brackets	2,242.00	2,466.20	B
A463CCRO09	2-bank manual valves complete with mounting brackets, 20 bar	389.00	427.90	B
A463CCRO10	3-bank manual valves complete with mounting brackets, 20 bar	273.00	300.30	B
A463051	Manual shut-off valve, 13mm tail, 20 bar	58.00	63.80	B
A463050	Blank ARAG valves	34.00	37.40	B
G8372023	Electric valve bank, 5-section complete with gauge port and mounting brackets	1,748.00	1,922.80	B
G8531010	Electric valve bank, 3-section complete with gauge port and mounting brackets (not pictured)	911.00	1,002.10	B
G8388001	Single electric boom shut-off valve, 3 wire for use with auto-rate controllers or basic electric controls, with bypass (suitable for 2 and 3-wire applications)	351.00	386.10	B

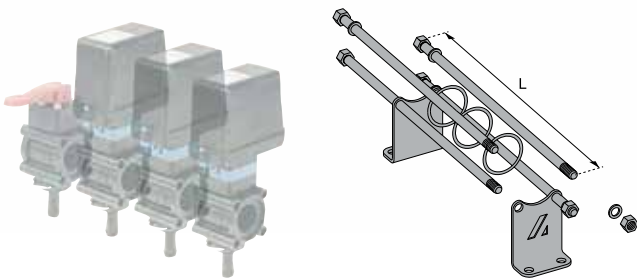

To make up your own bank of 2-wire or 3-wire motor valves (see below for valve options), order the correct kit for bolts, nuts and O-rings as shown. For end-caps and inlet/outlet fittings, see the valve adaptors section.

VALVE MOUNTING KITS

		\$ (EX. GST)	\$ (INC. GST)	PROD. CAT.
A463000.920	Kit for 2 valves, 150mm	41.00	45.10	B
A463000.930	Kit for 3 valves, 207mm	47.00	51.70	B
A463000.940	Kit for 4 valves, 264mm	53.00	58.30	B
A463000.950	Kit for 5 valves, 321mm	71.00	78.10	B
A463000.970	Kit for 7 valves, 436mm	91.00	100.10	B

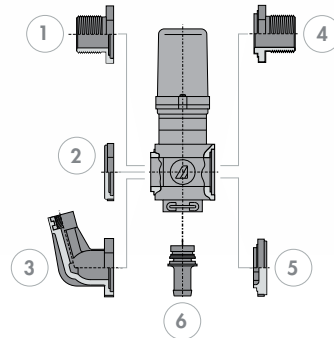

On the inlet and outlet of each motor valve there are a range of adaptors and fittings commonly used to go with the mounting kits. Use this valve adaptors diagram to choose the adaptors/fittings you require.

VALVE ADAPTORS

		\$ (EX. GST)	\$ (INC. GST)	PROD. CAT.
1. A463000.130	Male adaptor 3/4" (BSP)	10.00	11.00	B
1. A463000.140	Male adaptor 1" (BSP)	10.00	11.00	B
2. A463011.120	End cap	4.00	4.40	B
3. A463011.130	Pressure gauge adaptor 1/4" (BSP)	21.00	23.10	B
4. A463000.030	Male adaptor 3/4" (BSP)	9.00	9.90	B
4. A463000.040	Male adaptor 1" (BSP)	9.00	9.90	B
4. A463000.050	Male adaptor 1 1/4" (BSP)	9.00	9.90	B
5. A463011.110	End cap	5.00	5.50	B
6. A463001.113	Hosetail 13mm	9.00	9.90	B
6. A463001.116	Hosetail 16mm	9.00	9.90	B
6. A463001.119	Hosetail 19mm	9.00	9.90	B
6. A463001.125M	Hosetail 25mm	10.00	11.00	B
AG10071V	O-ring to suit 863 flanges (Viton)	7.00	7.70	B
A454236.080V	O-ring to suit 873 flanges (Viton)	7.00	7.70	B

ACCESSORIES

GPS PRODUCTS



TOPXD-01



GD430-GLO-PL – MATRIX 430



90-02720 –
ANTENNA FOR MATRIX 430

Topcon Manual Guidance

Designed with the future in mind, the Topcon XD touchscreen console, including revamped proprietary (Horizon) software and Topcon Agriculture Platform (TAP) integration, allows full-feature customization. Customers can optimize investment by paying only for capabilities they need.

Off-the-shelf features include Guidelines, Tasks, ISO-UT, and TAP Market. All additional Horizon OS features are easily accessible and unlockable utilizing TAP via the console or personal device.

Matrix 430 system

Portable, simple guidance Matrix 430 system for use in agriculture. 110mm (4.3") full colour, high-contrast touchscreen with on-screen numerical prompts. Minimal set up needed – guidance options include straight A-B, curved A-B, circle pivot and last pass. Handy return-to-point and boundary functions standard. Area counter displays applied area during operation and elapsed time counter measures current job-time. Standard with patch antenna for use where satellite reception is good. Optional 90-02720 antenna.

GPS GUIDANCE SYSTEMS

		\$ (EX. GST)	\$ (INC. GST)	PROD. CAT.
TOPXD-01	Topcon Manual Guidance with receiver and XD Console	4,760.00	5,236.00	D
GD430-GLO-P-L	Matrix 430 system	4,914.00	5,405.40	B
90-02720	Upgrade antenna for Matrix 430 to improve GPS reception in areas where signal is weak	1,723.00	1,895.30	B

ACCESSORIES

SPRAYING TOOLS & COVERAGE

Croplands has a great range of useful tools for checking or upgrading the performance of your sprayer. Calibrate and maintain your nozzles with ease.



LH9210



LH9205



LH6001

			\$ (EX. GST)	\$ (INC. GST)	PROD. CAT.
L-H9210	Electronic spray tip pressure tester <ul style="list-style-type: none"> • Can measure in psi, kPa and bar • Accurate to within +/- 1 psi, 0.07 bar or 7kPa • 5-year battery life (depending on use) 	<ul style="list-style-type: none"> • Easily fits to the nozzle body • LCD display shows nozzle pressure and unit of measure • For test gauge use only – not for continuous use • Reads from 3 to 160 psi (11 bar) 	417.00	458.70	D
L-H9220	Nozzle cleaner and multi-tool kit <ul style="list-style-type: none"> • Air-blast nozzle cleaner – simply charge it with air and it will blow out any grit or residue blocking your nozzle 	<ul style="list-style-type: none"> • Multi-tool with brush, plastic pick for removing a pre-orifice or residue, spanner wrench to make undoing nozzles so much easier and a utility hook for removing nozzle filters and the like. A must for all farmers 	157.00	172.70	D
L-H9205	Spot-on nozzle calibrator <ul style="list-style-type: none"> • Waterproof design, no moving parts • Easy one-hand operation, electronic display • Reads in GPM or L/min 	<ul style="list-style-type: none"> • Accurate to 0.01 L/min • Battery life approx. 2 years (has battery warning indicator) • Clear design allows for easy cleaning. Warning: only test your nozzles with water, not with mixed chemicals. Damage to the unit may occur 	518.00	569.80	D
L-H6001	WindMate™ handheld weather meter <ul style="list-style-type: none"> • Eight functions including temperature, wet bulb temperature, wind speed and direction, dewpoint, relative humidity, Delta T and comfort index. For more information see page 66 in the nozzle section 	<ul style="list-style-type: none"> • You simply cannot do without a WindMate™ to be sure you are spraying when conditions are right 	374.00	411.40	D
L-M1111	1L fluoro dye		143.00	157.30	D
L-M1115	4L fluoro dye		467.00	513.70	D
20301-1	Water-sensitive paper 76 x 26mm (3" x 1") pack 50		112.00	123.20	D
20301-2	Water-sensitive paper 76 x 52mm (3" x 2") pack 50		177.00	194.70	D

NOZZLE SELECTION



Spraying is a job that most farmers and growers do on a regular basis – whether for insect, disease or weed control, fertiliser applications or for soil additives, nozzle selection is a critical part of the process.

Broadacre

SprayWise Stewardship Program	59
Nozzle Cereal Segment Guide	60
Nozzle Flow Chart	62
Spray Quality Charts	64
Agrotop Nozzle Selection	66
ALBUZ Nozzle Selection	67
Hypro Nozzle Selection	68
TeeJet Nozzle Selection	69
Nozzle Caps	70
Nozzle Bodies and Filters	71
Spray Nozzles Wide Angle Flat and Fertiliser	72

Horticulture

Spray Nozzles Specialised Application	73
Nozzle Bodies and Caps for Horticulture	78
TurboDrop® Nozzles Narrow Angle AI	78
Disc and Core Nozzles	79

NUFARM

SPRAYWISE

Minimising spray drift is a major goal in all agricultural areas.



It is more important than ever that the agricultural industry demonstrates responsible chemical usage to reduce the need for severe application restrictions.

The SprayWise stewardship program is a Nufarm and Croplands initiative to encourage best-practice spraying and drift management techniques.

Giving you access to tools, research results and training courses to assist you to better understand spray application parameters and to better manage your spraying activities.

SprayWise Application Handbooks are used widely by specialist application consultants.



SPRAYWISE BROADACRE
APPLICATION HANDBOOK



SPRAYWISE
LOGBOOK















SPRAYWISE HORTICULTURE
APPLICATION HANDBOOK

ORDER CODE	DESCRIPTION	\$ (EX. GST)	\$ (INC. GST)	PROD. CAT.
SPRAYWISEBK	SprayWise Broadacre Application Handbook	54.00	59.40	D
SPRAYWISELOG	SprayWise Logbook	49.95	54.95	D
SPRAYWISEHK	SprayWise Horticulture Application Handbook	45.36	49.90	D

NOZZLE CEREAL GUI

LOW DRIFT / 2,4-D NOZZLES

Pre-emergent nozzles		Pre-orifice nozzles		Low-pressure air-induction nozzles	
TURBODROP XL (D)	TTI TURBO TEEJET INDUCTION FLAT FAN TIP	DG DRIFT GUARD FLAT FAN TIP	ALBUZ ADI	TDAM	CVI
					
<p>PRESSURE RANGE</p>  <p>1-8 BAR</p>	<p>PRESSURE RANGE</p>  <p>1-7 BAR</p>	<p>PRESSURE RANGE</p>  <p>1-5 BAR</p>	<p>PRESSURE RANGE</p>  <p>2-4 BAR</p>	<p>PRESSURE RANGE</p>  <p>1-6 BAR</p>	<p>PRESSURE RANGE</p>  <p>1-4 BAR</p>
<ul style="list-style-type: none"> • Ideal pressure range: 2-4 bar • Uses: weed control, plant health and liquid fertilisers • Up to 90% drift reduction 	<ul style="list-style-type: none"> • Ideal pressure range: 3-4 bar • Uses: weed control and plant health, both contact and systemic 	<ul style="list-style-type: none"> • Ideal pressure range: 2-3 bar • Uses: weed control and plant health 	<ul style="list-style-type: none"> • Ideal pressure range: 2-3 bar • Uses: weed control and plant health 	<ul style="list-style-type: none"> • Ideal pressure range: 3-4 bar • Uses: weed control and plant health 	<ul style="list-style-type: none"> • Ideal pressure range: 1.5-3 bar • Uses: weed control and plant health
<ul style="list-style-type: none"> ✓ Variable droplet spectra from coarse to fine as pressure increases ✓ Excellent drift reduction at lower pressures ✓ Two piece for easy disassembly ✓ Fast cap fitting 	<ul style="list-style-type: none"> ✓ Standard in polymer ✓ High-pressure air-induction nozzle ✓ Two piece with pre-orifice 	<ul style="list-style-type: none"> ✓ Standard in polymer ✓ Pre-orifice plate ✓ Reduces drift-prone ✓ Small droplets ✓ (Also available in Visi-stainless steel in some sizes in 80°) 	<ul style="list-style-type: none"> ✓ Pink ceramic orifice for excellent wear and spray precision ✓ Compact design, easy to dismantle and clean ✓ Excellent coverage potential for selected use and the right spraying conditions 	<ul style="list-style-type: none"> ✓ Excellent value, proven performer ✓ Predominantly coarse-medium droplets for good coverage ✓ Compact design ✓ Protected air inlets to avoid blockage ✓ Two piece for easy cleaning, no seals ✓ Also available as an off-centre nozzle 	<ul style="list-style-type: none"> ✓ Pink ceramic orifice for long life and precise spray quality ✓ Predominantly very coarse to coarse ✓ Available in 80° and 110° ✓ Anti-clogging design and protected double air-intake orifice ✓ Compact design ✓ Also available as an off-centre nozzle

GROWTH STAGE

Pre-plant

Emergence

Tillering

Stem elongation

DE

There's a nozzle to suit every step of your cereal cropping program.

Fungicide nozzles

CVI – TWIN



PRESSURE RANGE



- Ideal pressure range: 2 bar
- Uses: contact and systemic products

- ✓ Pink ceramic orifice for long life and precise spray quality
- ✓ The inclination of the jets improves the penetration into the vegetation
- ✓ Air-induction nozzle
- ✓ Angle between the jets 65°

LOW DRIFT / 2,4-D NOZZLES

Fallow nozzles

TTI TWIN



PRESSURE RANGE

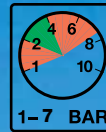

- Ideal pressure range: 1.5–7 bar
- Uses: contact and systemic products

- ✓ Standard in polymer
- ✓ High-pressure air induction nozzle
- ✓ All-in-one moulded nozzle and Quick TeeJet® cap design provides automatic spray alignment

TURBODROP XL (D)



PRESSURE RANGE

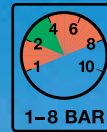

- Ideal pressure range: 2–4 bar
- Uses: weed control, plant health and liquid fertilisers
- Up to 90% drift reduction

- ✓ Variable droplet spectra from coarse to fine as pressure increases
- ✓ Excellent drift reduction at lower pressures
- ✓ Two piece for easy disassembly
- ✓ Fast cap fitting

TTI TURBO TEEJET INDUCTION FLAT FAN TIP



PRESSURE RANGE



- Ideal pressure range: 2–4 bar
- Uses: weed control and plant health, both contact and systemic

- ✓ Standard in polymer
- ✓ High-pressure air-induction nozzle
- ✓ Two piece with pre-orifice







Heading







Ripening

Harvest

Fallow

QUALITY CHARTS

		DUAL-ANGLE NOZZLES	WEED-IT	LOW-PRESSURE AIR-INDUCTION				
		ALBUZ	AGROTOP	AGROTOP	ALBUZ	HYPRO	HYPRO	TEEJET
		CVI-TWIN	Spot Fan	AirMix®	CVI	Guardian Air	ULD-120	AIXR
								
NOZZLE SIZE	BAR							
01	1.5			M				
	2.0			M				
	3.0			F				
	4.0	Not available in this size	Not available in this size	F	Not available in this size	Not available in this size	Not available in this size	Not available in this size
	5.0			F				
	6.0			F				
	7.0							
	8.0							
015	1.5	XC			VC	UC	UC	VC
	2.0	XC		XC	VC	XC	XC	C
	3.0	VC		C	VC	C	VC	C
	4.0	C	Not available in this size	C		M	C	M
	5.0	M		C		M	C	M
	6.0	M		M		M	M	M
	7.0					M	M	
	8.0					M	M	
02	1.5	XC			VC	XC	UC	VC
	2.0	VC		C	VC	VC	XC	VC
	3.0	VC		C	C	M	C	C
	4.0	C	Not available in this size	M		M	C	M
	5.0	M		M		M	M	M
	6.0	M		M		M	M	M
	7.0					M	M	
	8.0					M	M	
025	1.5	XC			VC	XC	XC	XC
	2.0	XC		VC	VC	VC	XC	VC
	3.0	XC		C	C	C	C	VC
	4.0	VC	Not available in this size	C		M	C	C
	5.0	C		M		M	M	C
	6.0	C		M		M	M	M
	7.0					M	M	
	8.0					M	M	
03	1.5	XC	UC		VC	UC	XC	XC
	2.0	XC	UC	VC	VC	XC	XC	VC
	3.0	VC	XC	C	C	VC	C	VC
	4.0	C	XC	C		C	C	C
	5.0	C		C		M	M	C
	6.0	C		M		M	M	M
	7.0					M	M	
	8.0					M	M	
04	1.5	XC	UC		VC	XC	UC	XC
	2.0	XC	UC	VC	C	VC	UC	XC
	3.0	VC	XC	C	C	C	UC	VC
	4.0	C	XC	C		M	XC	VC
	5.0	C		C		M	XC	C
	6.0	C		M		M	VC	C
	7.0					M	C	
	8.0					C	C	
05	1.5	VC			VC	XC	UC	XC
	2.0	VC		VC	C	VC	UC	XC
	3.0	C		C	C	C	XC	VC
	4.0	C	Not available in this size	C		C	XC	VC
	5.0	M		M		C	VC	C
	6.0	M		M		M	VC	C
	7.0					M	C	
	8.0					C	C	

		HIGH-PRESSURE AIR-INDUCTION				PRE-ORIFICE		INCLINED FLAT FAN
		ALBUZ	AGROTOP	TEEJET	TEEJET	ALBUZ	TEEJET	HYPRO
MODEL		AVI	TD-XL D	TTI	TTI60 TwinJet	ADI-110	DG-110	FC-3D100
								
NOZZLE SIZE	BAR							
01	1.5	VC	Not available in this size	Not available in this size	UC	F	Not available in this size	Not available in this size
	2.0	VC			UC	F		
	3.0	VC			UC	F		
	4.0	C			XC			
	5.0	C			VC			
	6.0	C			VC			
	7.0	C			C			
	8.0							
015	1.5		Not available in this size	UC	UC	M	M	C
	2.0	VC		UC	UC	F	F	M
	3.0	VC		UC	XC	F	F	F
	4.0	VC		XC	VC			F
	5.0	VC		XC	VC			F
	6.0	C		XC	VC			F
	7.0	C		VC	C			F
	8.0							
02	1.5		UC	UC	UC			C
	2.0	VC	UC	UC	UC	M	M	M
	3.0	VC	XC	UC	UC	M	M	M
	4.0	VC	XC	UC	XC	F	M	F
	5.0	VC	XC	XC	XC			F
	6.0	VC	VC	XC	VC			F
	7.0	C		VC	VC			F
	8.0							
025	1.5		UC	UC	UC		Not available in this size	C
	2.0	XC	UC	UC	UC	M		C
	3.0	VC	XC	UC	UC	M		M
	4.0	VC	XC	UC	XC	F		M
	5.0	VC	XC	XC	XC			M
	6.0	VC	VC	XC	VC			F
	7.0	VC		XC	VC			F
	8.0							
03	1.5		UC	UC	UC			VC
	2.0	XC	UC	UC	UC	M	C	C
	3.0	XC	UC	UC	UC	M	M	M
	4.0	VC	XC	UC	XC	F	M	M
	5.0	VC	XC	UC	XC			M
	6.0	VC	XC	XC	VC			F
	7.0	VC		XC	VC			F
	8.0							
04	1.5		UC	UC	UC			VC
	2.0		UC	UC	UC	C	C	VC
	3.0	XC	UC	UC	UC	C	M	C
	4.0	VC	XC	UC	XC	M	M	M
	5.0	VC	XC	XC	XC			M
	6.0	VC	XC	XC	XC			M
	7.0	VC		XC	VC			M
	8.0	VC						
05	1.5		UC	UC		Data not available		VC
	2.0	XC	UC	UC			C	VC
	3.0	XC	UC	UC			C	C
	4.0	XC	UC	UC			M	C
	5.0	VC	UC	UC				M
	6.0	VC	XC	XC				M
	7.0	VC		XC				M
	8.0							

NOTE: SPRAY QUALITY DATA may differ from previous versions of this chart as manufacturers undertake new testing requirements. All data has been sourced from the GRDC Spray Quality data table published in January 2020. Always check current spray quality information according to ASABE 572.1 or BCPC for older data.

NOZZLE SELECTION

AGROTOP



AIRMIX®



TURBODROP CERAMIC



TURBODROP XL (D)



TDSF-4003

NOZZLE OPTIONS

KEY INFORMATION

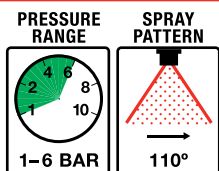

- Ideal pressure range: 1–6 bar
- Uses: weed control and plant health
- Up to 90% drift reduction

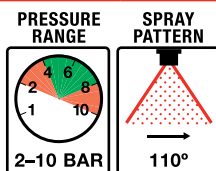

- Ideal pressure range: 4–8 bar
- Uses: weed control, plant health and liquid fertilisers
- Up to 95% drift reduction

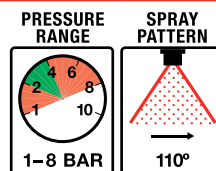

- Ideal pressure range: 2–4 bar
- Uses: weed control, plant health and liquid fertilisers
- Up to 90% drift reduction

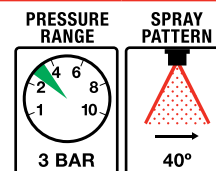

- Ideal pressure range: 3 bar ONLY
- Low drift option for WEED IT spot sprayers

KEY BENEFITS

- Excellent value
- Proven performer
- Predominantly coarse to medium droplets for good coverage
- Compact design
- Protected air inlets to avoid blockage
- Two piece for easy cleaning, no seals
- Also available as an off-centre nozzle

- Ceramic injector orifice and exit nozzle
- Small droplet size variation over pressure range
- Up to three times the life of polyacetal nozzles
- Two piece for easy disassembly
- Excellent penetration using high pressure

- Variable droplet spectra from coarse to fine as pressure increases
- Excellent drift reduction at lower pressures
- Two piece for easy disassembly

- Specifically designed for use with the WEED IT optical spot sprayer
- Excellent drift reduction
- Two piece for easy cleaning, no seals

SPRAY QUALITY	SEE PAGE 64-65			
AVAILABLE SIZES	01 to 06	01 to 10	01 to 08	03-04
ORDER CODE	TDAM-110***	TDCFFC110***	TDXLD-***	TDSF-40**

*** DENOTES NOZZLE SIZE (I.E. 015, 02, 025, 03 ETC)

SINGLE NOZZLE PRICE	\$(EX. GST)	13.00	\$(EX. GST)	44.00	\$(EX. GST)	20.00	\$(EX. GST)	14.00
	\$(INC. GST)	14.30	\$(INC. GST)	48.40	\$(INC. GST)	22.00	\$(INC. GST)	15.40
PROD. CAT.	C		C		C		C	
10 PACK AIRMIX® NOZZLES – SIZES 015 TO 04	\$(EX. GST)	100.00	NA		NA		NA	
	\$(INC. GST)	110.00						
ORDER CODE	PR**-TDAM **10 = size 015, 11 = 02, 12 = 03, 13 = 04		NA		NA		NA	
100 PACK AIRMIX® NOZZLES – SIZES 015 TO 04	\$(EX. GST)	950.00						
	\$(INC. GST)	1,045.00						
ORDER CODE	PR***-TDAM100 **10 = size 015, 11 = 02, 12 = 03, 13 = 04		NA		NA		NA	

WEED-IT ONLY

NOZZLE SELECTION

ALBUZ



NOZZLE OPTIONS

KEY INFORMATION

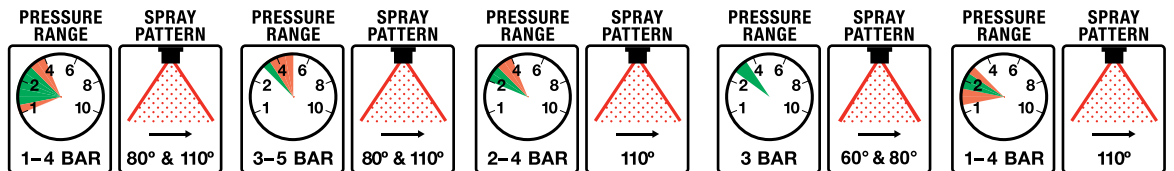

- CVI:**
 - Ideal pressure range: 1.5–3 bar
 - Uses: weed control and plant health
 - Up to 90% drift reduction
- AVI:**
 - Ideal pressure range: 3–3.5 bar
 - Uses: weed control, plant health and liquid fertilisers
 - Up to 95% drift reduction
- ADI:**
 - Ideal pressure range: 2–3 bar
 - Uses: weed control and plant health
 - Reduces fine droplets by 50%
- ATF:**
 - Ideal pressure range: 3 bar
 - Full cone nozzle producing medium to fine droplets
 - Great coverage with full cone pattern for use on WEED-IT spot sprayers
- CVI-TWIN:**
 - Ideal pressure range: 2 bar
 - Uses: contact and systemic products

KEY BENEFITS

- CVI:**
 - Pink ceramic orifice for long life and precise spray quality
 - Predominantly coarse to very coarse
 - Available in 80° and 110°
 - Anti-clogging design and protected double air-intake orifice
 - Compact design
 - Also available as an off-centre nozzle
- AVI:**
 - Pink ceramic orifice for excellent wear and spray precision
 - Anti-clogging design and double air-intake orifice
 - Available in 80° and 110°
 - Also available as an off-centre nozzle and as a twin nozzle
- ADI:**
 - Pink ceramic orifice for excellent wear and spray precision
 - Compact design, easy to dismantle and clean
 - Excellent coverage potential for selected use and the right spraying conditions
- ATF:**
 - ALBUZ durable pink ceramic maintains nozzle performance and precision
 - Flow-rate characteristics, colour code meets international ISO standards
 - Can be used on a sprayer boom (spacing nozzle between 35cm and 50 cm)
 - Recommended pressure on sprayer boom: 3 bar
- CVI-TWIN:**
 - Pink ceramic orifice for long life and precise spray quality
 - The inclination of the jets improves the penetration into the vegetation
 - Air-induction nozzle
 - Angle between the jets 65°

SPRAY QUALITY	SEE PAGE 64–65									
AVAILABLE SIZES	015 to 05		01 to 10		02 to 04 in 60° and 80°		03 to 04		015 to 05	
ORDER CODE	AZ-CVI-110*** (110°) AZ-CVI-80*** (80°)		AZ-AVI-***-110C (110°) AZ-AVI-***-80C (80°)		AZ-ADI-***-110C		AZ-ATF-***-60C AZ-ATF-***-80C		AZ-CVIT-110***	
*** DENOTES NOZZLE SIZE (I.E. 015, 02, 025, 03 ETC)										
SINGLE NOZZLE PRICE	\$ (EX. GST)	30.00	\$ (EX. GST)	30.00	\$ (EX. GST)	14.00	\$ (EX. GST)	14.00	\$ (EX. GST)	35.00
	\$ (INC. GST)	33.00	\$ (INC. GST)	33.00	\$ (INC. GST)	15.40	\$ (INC. GST)	15.40	\$ (INC. GST)	38.50
PROD. CAT.	C		C		C		C		C	

WEED-IT ONLY

NOZZLE SELECTION

HYPRO



ULTRA LO-DRIFT



GUARDIAN AIR



3D

NOZZLE OPTIONS

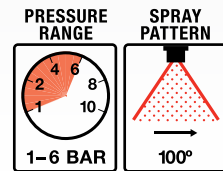
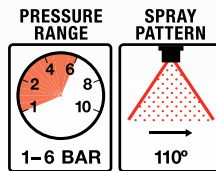
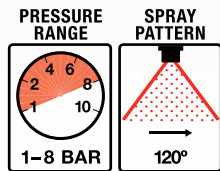

KEY INFORMATION

DRIFT REDUCING, DUAL AIR-INDUCTION

- Ideal for systemic herbicide applications where drift control is crucial – ideal for 2,4-D applications
- Wide, 3-dimensional pattern creates multiple angles for the spray to cover the target
- Ideal for pre and post-emergent applications of systemic herbicides
- Designed to eliminate driftable droplets, without sacrificing coverage

ENHANCED COVERAGE AIR-INDUCTION

- Ideal for contact herbicide applications due to exceptional coverage through air-induction
- Speed-optimised inclined pattern provides superior droplet deposition and retention on targets
- Ideal for high-coverage application of contact herbicides
- Industry-leading coverage among air-induced spray nozzles

INCLINED ENHANCED COVERAGE

- Alternative incline, all-purpose nozzle for optimum spray coverage – PWM system compatible
- Optimised spray angle and incline for coverage and uniformity across the boom
- Ideal for post-emergent health protectants. Also good for high-coverage herbicide applications
- Droplet spectrum optimised for coverage, fewer droplets bounce off or drift away

SPRAY QUALITY	SEE PAGE 64-65					
AVAILABLE SIZES	015 to 08 (polyacetal)		015 to 05 (polyacetal)		015 to 08 (polyacetal)	
ORDER CODE	FC-ULD120-***		FC-GA110-***		FC-3D100-***	
*** DENOTES NOZZLE SIZE (I.E. 015, 02, 025, 03 ETC)						
SINGLE NOZZLE PRICE	\$ (EX. GST)	33.00	\$ (EX. GST)	29.00	\$ (EX. GST)	29.00
	\$ (INC. GST)	36.30	\$ (INC. GST)	31.90	\$ (INC. GST)	31.90
PROD. CAT.	B		B		B	

NOZZLE SELECTION TEEJET



AIXR AIR-INDUCTION
FLAT FAN TIP



AITTJ60 AIR-INDUCTION
TURBO TWINJET TWIN
FLAT FAN TIP



TTI TURBO TEEJET
INDUCTION FLAT
FAN TIP



TTI TWINJET AIR
INDUCTION TWIN FLAT
FAN SPRAY TIP

NOZZLE OPTIONS

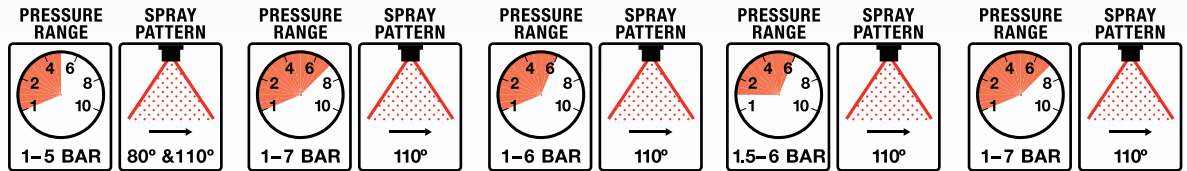

KEY INFORMATION

- Standard in polymer
- Pre-orifice plate
- Reduces drift-prone
- Small droplets
- Also available in Visi-stainless steel in some sizes in 80°
- Standard in polymer
- Low-pressure air-induction nozzle
- Two piece with pre-orifice
- Standard in polymer
- Dual outlet design
- Air-induction nozzle
- 60° angle between forward and back spray pattern
- Standard in polymer
- High-pressure air-induction nozzle
- Two piece with pre-orifice
- Standard in polymer
- High-pressure air-induction nozzle
- All-in-one moulded nozzle and Quick TeeJet® cap design provides automatic spray alignment

SPRAY QUALITY	SEE PAGE 64-65									
AVAILABLE SIZES	015 to 05		015 to 06		02 to 08 (some larger sizes on request)		015 to 06		02 to 08	
ORDER CODE	DG110***-VP		AIXR110***-VP		AITTJ60-110***VP		TTI110***-VP		TTI60-110***VP	
*** DENOTES NOZZLE SIZE (I.E. 015, 02, 025, 03 ETC)										
SINGLE NOZZLE PRICE	\$ (EX. GST)	13.00	\$ (EX. GST)	16.00	\$ (EX. GST)	19.00	\$ (EX. GST)	25.00	\$ (EX. GST)	30.00
	\$ (INC. GST)	14.30	\$ (INC. GST)	17.60	\$ (INC. GST)	20.90	\$ (INC. GST)	27.50	\$ (INC. GST)	33.00
25 PACK	\$ (EX. GST)	300.00	\$ (EX. GST)	335.00	NA		\$ (EX. GST)	600.00	NA	
	\$ (INC. GST)	330.00	\$ (INC. GST)	368.50			\$ (INC. GST)	660.00		
ORDER CODE	PR**-DG **10 = size 015, 11 = 02, 12 = 03, 13 = 04		PR**-AIXR **10 = size 015, 11 = 02, 12 = 03, 13 = 04, 14 = 025				PR**-TTI **10 = size 015, 11 = 02, 12 = 03, 13 = 04, 14 = 025			
PROD. CAT.	B		B		B		B		B	

NOZZLE SELECTION

CAPS



Quick TeeJet Cap



Quick TeeJet Seal

CP19438-EPR
(EPDM standard)
CP19438-VI
(Viton optional standard)

1	2	3	4	5	6	7	8	10
Black	White	Red	Blue	Green	Yellow	Brown	Orange	Lilac

CAP	NOZZLES/SEALS TO SUIT CAPS	ORDER CODE	DESCRIPTION	\$ (EX. GST)	\$ (INC. GST)	PROD. CAT.
	<ul style="list-style-type: none"> AirMix® TeeJet XR, DG, TT, AIXR (smaller capacities to size 08) ALBUZ AXI, ADI, CVI, CVI TWIN, CVI 80 	114441-*-CELR	Cap and seat gasket set	3.00	3.30	B
		PR20-*	Pack of 10 caps and seats	30.00	33.00	
	<ul style="list-style-type: none"> Seal for use with nozzle caps 	CP19438-EPR	Seal for nozzle caps, EPDM	1.30	1.43	B
		PR60	Pack of 10 seals for nozzle caps	16.00	17.60	
	<ul style="list-style-type: none"> Seal for use with nozzle caps 	CP19438-VI	Seal for nozzle caps, Viton	4.50	4.95	B
	<ul style="list-style-type: none"> TeeJet flat spray tips (smaller capacities) – see above. Tips can be positioned in choice of 2 spray plane directions: parallel or perpendicular to wings of Quick TeeJet cap 	25596-8-NYR	Cap and seat gasket set	3.00	3.30	B
	<ul style="list-style-type: none"> TJ TwinJet / TJ60-Spray Tip / ALBUZ AVI, AVI TWIN, ESI, EXA, AIUB TeeJet / TTI Air-induction Turbo TeeJet SJ3 StreamJet 	114443-*-CELR	Cap and seat gasket set	3.00	3.30	B
	<ul style="list-style-type: none"> TF-VS Turbo FloodJet / TK-VS FloodJet 	25600-*-NYR	Cap and seat gasket set	3.00	3.30	B
	<ul style="list-style-type: none"> TK FloodJet / FL FullJet / TX ConeJet / TG Full Cone 	114445-*-CELR	Cap and seat gasket set	3.00	3.30	B
	<ul style="list-style-type: none"> Ceramic Disc-Core/TXB ConeJet ALBUZ TVI 	26278-1-NYR	Cap and seat gasket set	3.00	3.30	B
	<ul style="list-style-type: none"> For use with Hardi nozzle bodies TeeJet flat fan spray tips Turbo TeeJet spray tips AirMix® nozzles 	23306H-1-CELR	Cap and seat gasket for Hardi retro-fit cap to suit Hardi spray bodies. Available in black only	3.00	3.30	B
	<ul style="list-style-type: none"> For use with Hardi nozzle bodies TJ TwinJet AI TeeJet, AIUB TeeJet spray tips flat TTI Air-induction Turbo TeeJet 	21398H-1-CELR	Cap and seat gasket for Hardi retro-fit cap to suit Hardi spray bodies. Available in black only	3.00	3.30	B







* Denotes colour code as shown above - not all colours may be available.

	ORDER CODE	DESCRIPTION	\$ (EX. GST)	\$ (INC. GST)	PROD. CAT.
	CP1325	TeeJet® brass 11/16" threaded cap	3.50	3.85	B
	CP8027-NYB	TeeJet® nylon 11/16" threaded cap	3.00	3.30	B
	CP8027-1-NYB	TeeJet® nylon 11/16" threaded cap, extra long	3.00	3.30	B
	CP3942	TeeJet® brass blanking plug	1.30	1.43	B
	114447-1-CELR	Blanking cap with seal, black only	6.00	6.60	B
	QJ90-2-NYR	QJ adaptor cap comes with gasket and ¼" female thread	13.00	14.30	B
	QJ4676-¼-NYR	QJ adaptor cap, 90°, comes with gasket and ¼" female thread	6.00	6.60	B
	QJ4676-90-¼-N	QJ adaptor cap, 90°, comes with gasket and ¼" female thread	13.00	14.30	B







NOZZLE SELECTION

BODIES & FILTERS

NOZZLE BODIES

	DESCRIPTION	REPLACES	FEATURES	\$ (EX. GST)	\$ (INC. GST)	PROD. CAT.
 QJ17560A-1/2-NY	Teejet 1/2" single drop nozzle body for wet boom	TeeJet: 2.20 QJ17560A-1/2-NYB ARAG: 402745	<ul style="list-style-type: none"> Low-pressure drop at any given flow rate Unique check valve design reduces restrictions – supports faster field speeds and direct fertiliser applications 	10.00	11.00	B
 4221N-B123	PROFLO 3/4" single drop nozzle body for wet boom	TeeJet: QJ17560A-3/4-NYB ARAG: 402755	<ul style="list-style-type: none"> Bayonet attachment for correct flat fan nozzle alignment Compact design – less interference with boom structures 10mm nib 20-bar rated 	17.00	18.70	B
 4243N-B322V	PROFLO 1/2" triple drop nozzle body for wet boom	TeeJet: QJ363C-1/2-NYB	<ul style="list-style-type: none"> Tab for boom clamp provided Low-pressure drop at any given flow rate Unique check valve design reduces restrictions – supports faster field speeds and direct fertiliser applications 	40.00	44.00	B
 4243N-B323V	PROFLO 3/4" triple drop nozzle body for wet boom	TeeJet: QJ363C-3/4-NYB	<ul style="list-style-type: none"> Turret-indexing design eliminates seizing issues common on other types Bayonet attachment for correct flat fan nozzle alignment 	50.00	55.00	B
 4243N-B324V	PROFLO 1" triple drop nozzle body for wet boom	TeeJet: QJ363C-1-NYB	<ul style="list-style-type: none"> Compact design 10mm nib 20-bar rated 	55.00	60.50	B
 24216-1/2-NYB	Compact triple nozzle body for wet booms – 1/2"		Vertical turret for use in situations where space is an issue	45.00	49.50	B
 24216-3/4-NYB	Compact triple nozzle body for wet booms – 3/4"		Vertical turret for use in situations where space is an issue (also available in 1")	45.00	49.50	B
 A402735	Single drop nozzle body for wet boom – 7mm nib		Hinged clamp single nozzle body with diaphragm check valve for quick connect caps with 7mm nib – suits MBX and MAX series manual fold booms	11.00	12.10	B
 QJ39685-2-500-N	Dry boom nozzle body – 1/2" tee type		Dry boom nozzle body with diaphragm check valve for quick connect caps – tee type	17.00	18.70	B
 QJ39685-1L500-N	Dry boom nozzle body – 1/2" left elbow		Dry boom nozzle body with diaphragm check valve for quick connect caps – left elbow for boom end	17.00	18.70	B
 QJ39685-1R500-N	Dry boom nozzle body – 1/2" right elbow		Dry boom nozzle body with diaphragm check valve for quick connect caps – right elbow for boom end	17.00	18.70	B
 B716.617.2	Brass roll-over nozzle body		High-pressure roll-over nozzle body with non-drip diaphragm check valve – comes with 2 caps (no nozzles supplied). For more information on horticultural nozzle holders, see page 74	65.00	71.50	B

NOZZLE FILTERS

	ORDER CODE	DESCRIPTION	\$ (EX. GST)	\$ (INC. GST)	PROD. CAT.
 8079-PP-*		TeeJet® polypropylene strainer, *50, *80 or *100 mesh screen	3.00	3.30	B
 PR51		Pack of 10 x 8079-PP-50 strainers	31.00	34.10	B
 PR52		Pack of 10 x 8079-PP-100 strainers	31.00	34.10	B
 4193A-PP-5-*SS		TeeJet® polypropylene strainer with check valve for 5 psi, *50 or *100 mesh screen	11.00	12.10	B
 4193A-5-*SS		TeeJet® brass strainer with check valve for 5 psi, *50 or *100 mesh screen	13.00	14.30	B
 4067-SS-*		TeeJet® cup strainer, *50 or *100 mesh screen	4.00	4.40	B
 4514-NY-*		TeeJet® nylon slotted strainer, for suspended solids, *10, *20 and *32	3.00	3.30	B

NOZZLE SELECTION

WIDE ANGLE FLAT FERTILISER

Thanks to the exceptional wear resistance of ALBUZ® pink ceramic, these nozzles can be used to spray suspension fertilisers. Flat jet (30° to 165° angle) provide coarse droplets without drift.

AZ-MSI-***

USE AND FEATURES

\$ (EX. GST)

\$ (INC. GST)

PROD. CAT.



- Wide-angle flat fan Flood Jet for use with suspension fertilisers and some herbicides
- Commonly used in sugar cane and other row crops
- Ideal for soil-applied products in particular
- Exceptional wear resistance using pink ceramic surfaces
- Recommended pressure range 0.5 to 2 bar

19.00

20.90

C

*** Denotes sizes as follows: AZ-MSI-025 = Lilac, AZ-MSI-03 = Blue, AZ-MSI-04 = Red, AZ-MSI-05 = Brown, AZ-MSI-06 = Grey, AZ-MSI-08 = White, AZ-MSI-10 = Light Blue, AZ-MSI-15 = Light Green

FLOW RATE

BAR	Lilac	Blue	Red	Brown	Grey	White	Light Blue	Light Green
0.5	0.42	0.51	0.68	0.85	1.02	1.35	1.69	2.54
1	0.59	0.71	0.94	1.18	1.42	1.89	2.36	3.54
1.5	0.72	0.86	1.15	1.43	1.72	2.29	2.87	4.3
2	0.82	0.99	1.32	1.65	1.98	2.63	3.29	4.94
2.5	0.92	1.1	1.47	1.83	2.2	2.93	3.66	5.5
3	1	1.2	1.6	2	2.4	3.2	4	6
3.5	1.08	1.29	1.72	2.15	2.58	3.45	4.31	6.46
4	1.15	1.38	1.84	2.3	2.76	3.67	4.59	6.89

BAR	ANGLE OF SPRAY							
1	96	96	96	104	108	117	133	150
1.5	103	103	104	110	114	122	140	154
2	107	108	111	114	118	127	142	156
3	112	113	116	116	124	132	144	160
4	116	116	121	122	128	135	147	162

AZ-ESI-***

SIZES

TYPE SPECIFICATION AND USE

FEATURES

\$ (EX. GST)

\$ (INC. GST)

PROD. CAT.

SIZE/ORDER CODE

FLOW RATE (L/MIN)



015 to 06

- Specifically designed for fertiliser application
- Pink ceramic calibrated pre-orifice
- Pressure range: 1–4 bar
- Uses: predominant use in ground crops

- 6 streams provide very coarse droplets for excellent distribution
- Long-wear life
- Allows a wide range of applications at varying speeds
- ISO colour coded. Tip only (caps and seal extra)
- Fits standard 50cm nozzle body spacings
- 110° pattern

14.00

15.40

C

ALBUZ ESI

PRESSURE (BAR)

	1	1.5	2	2.5	3	3.5	4
AZ-ESI-015	0.37	0.44	0.50	0.55	0.60	0.64	0.68
AZ-ESI-02	0.52	0.61	0.68	0.74	0.80	0.85	0.90
AZ-ESI-025	0.64	0.76	0.85	0.93	1.00	1.06	1.10
AZ-ESI-03	0.77	0.91	1.02	1.12	1.20	1.28	1.35
AZ-ESI-04	1.03	1.21	1.36	1.49	1.60	1.70	1.80
AZ-ESI-05	1.35	1.56	1.73	1.87	2.00	2.11	2.22

FC-ESI-***

SIZES

TYPE SPECIFICATION AND USE

FEATURES

\$ (EX. GST)

\$ (INC. GST)

PROD. CAT.

SIZE/ORDER CODE

FLOW RATE (L/MIN)



015 to 20

- Specifically designed for fertiliser application
- Pink ceramic calibrated pre-orifice
- Pressure range: 1–4 bar
- Uses: soil seeded crops

- 6 streams provide very coarse droplets for excellent distribution
- Long-wear life
- Allows a wide range of applications at varying speeds
- Includes cap and seal
- Fits standard 50cm nozzle body spacings
- 110° pattern

29.00

31.90

B





HYPRO ESI

PRESSURE (BAR)

	1	1.5	2	2.5	3	4
FC-ESI-110015	0.35	0.42	0.49	0.55	0.60	0.69
FC-ESI-11002	0.46	0.57	0.65	0.73	0.80	0.92
FC-ESI-110025	0.58	0.71	0.82	0.91	1.00	1.15
FC-ESI-11003	0.69	0.85	0.98	1.10	1.20	1.39
FC-ESI-11004	0.92	1.13	1.31	1.46	1.60	1.85
FC-ESI-11005	1.15	1.41	1.63	1.83	2.00	2.31

NOZZLE SELECTION

SPECIALISED APPLICATION

NOZZLE	TYPE AND DESCRIPTION	ORDER CODE	SIZE, MATERIAL, ANGLE	\$ (EX. GST)	\$ (INC. GST)	PROD. CAT.
	ALBUZ OCI <ul style="list-style-type: none"> • Ceramic • Off centre 	AZ-OCI-**-80C	<ul style="list-style-type: none"> • 02, 03 and 04 sizes • Pink ceramic • 80° 	37.00	40.70	C
	ALBUZ AVI <ul style="list-style-type: none"> • Air-induction • Off centre 	AZ-AVI0C-80**	<ul style="list-style-type: none"> • 01 to 04 sizes • Pink ceramic • 80° 	58.00	63.80	C
	Turbo TurfJet <ul style="list-style-type: none"> • Wide-angle flat spray pattern • Extremely coarse droplets • Designed for turf applications • 1.5–5 bar pressure range 	¼TTJ**-VP	<ul style="list-style-type: none"> • 02 to 15 sizes • Polymer 	36.00	39.60	B
		¼TTJ**-VS	<ul style="list-style-type: none"> • 02 to 15 sizes • Stainless steel 	38.00	41.80	
	Turbo FloodJet <ul style="list-style-type: none"> • Wide-angle flat spray pattern • Extremely coarse droplets • Precise distribution pattern • 1–3 bar pressure range 	TF-VP*	<ul style="list-style-type: none"> • 2 to 10 sizes • Polymer 	7.00	7.70	B
		TF-VS*	<ul style="list-style-type: none"> • 2 to 10 sizes • Steel 	30.00	33.00	
	FloodJet <ul style="list-style-type: none"> • Wide-angle flat spray pattern • 1–3 bar pressure range 	TK-VS*	<ul style="list-style-type: none"> • 2 to 10 sizes • Steel 	26.00	28.60	B
	BoomJet <ul style="list-style-type: none"> • Large-capacity boomless nozzle • Extra-wide flat spray projection • Ideal for difficult access areas when spraying • Useful for liquid fertiliser applications 	5880-¾-2TOC**	<ul style="list-style-type: none"> • 10 to 40 sizes • Brass 	556.00	611.60	B
	XP BoomJet <ul style="list-style-type: none"> • Boomless flat spray nozzles • Useful for roadside, end-row, orchard or forestry applications • Extra-wide spray pattern • Left and right options • 1–4 bar pressure range • Excellent distribution 	B¼XP**L-VP B¼XP**R-VP	<ul style="list-style-type: none"> • 10, 20 and 25 ¼" sizes • Acetal left and right options 	108.00	118.80	B
		B½XP**L-VP B½XP**R-VP	<ul style="list-style-type: none"> • 40 and 80 ½" sizes • Acetal left and right options 	129.00	141.90	

NOZZLE SELECTION

BODIES & CAPS

KEY FEATURES











1. Caps for use with TurboDrop® AI nozzles in horticultural applications
2. Nozzle bodies and o-rings used on Croplands sprayers for horticulture

Note – the complete nozzle body, when ordered from Croplands, comes with a cap/caps to suit. When ordering caps and o-rings to suit TurboDrop® AI nozzles, use the codes on the right-hand side of the table below.

QUICK GUIDE

1. Choose the correct cap to suit the nozzle body on your sprayer
2. The TurboDrop® uni narrow-angle nozzles click together and remain in the cap once assembled. They cannot be disassembled – so choose the cap you need
3. Suitable o-rings are required for a complete seal – see table below



NOZZLE BODY	FITTED TO	CAP AND O-RING TO ORDER	DESCRIPTION	ORDER CODE	\$ (EX. GST)	\$ (INC. GST)	PROD. CAT.
 B716.617.2 (STANDARD TYPE)	Croplands Cropliner® sprayers, Silvan models and other brands	 B716.605.3	Brass cap	B716.605.3	3.00	3.30	B
 B73.610.105 (ORGANIC TYPE)	Croplands Cropliner® sprayers for organic spraying	 B716.605.3	Brass cap	B716.605.3	3.00	3.30	B
 B75.617.10F (STANDARD TYPE)	Croplands Cropliner® and Cropliner SP® front entry fan models	 B75.605.46	Brass cap	B75.605.46	3.00	3.30	B
 B264.612.172	Croplands Quantum™ sprayers	 B256.605.7	Nickel plated cap	B256.605.7	3.00	3.30	B
 B67.617.67	Croplands Quantum™ tower sprayers	 B256.605.7	Nickel plated cap	B256.605.7	3.00	3.30	B
O-RINGS TO SEAL THE CAPS ON ALL LISTED NOZZLE BODIES ABOVE	Croplands Quantum™ sprayers	 B73.602.22	O-ring, 16mm O.D. x 10.8 I.D.	B73.602.22	0.70	0.77	B

PRICING FOR NOZZLE BODIES SHOWN IN TABLE ABOVE

ORDER CODE	DESCRIPTION	\$ (EX. GST)	\$ (INC. GST)	PROD. CAT.
B716.617.2	Standard swing-over nozzle body, suits Croplands Cropliner sprayers	65.00	71.50	B
B73.610.105	Organic model swing-over nozzle body, suits Croplands Cropliner sprayers for organic applications	55.00	60.50	B
B75.617.10F	Swing-over nozzle body for Croplands front-entry fan models	65.00	71.50	B
B264.612.172	Single-swivel nozzle body for Croplands Quantum™ sprayers	19.00	20.90	B
B67.617.67	Non-drip body with shut off for Croplands Quantum™ sprayers	79.00	86.90	B

NOZZLE SELECTION

DISCS & CORES

NOZZLES - DISCS AND CORES

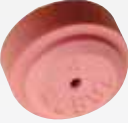
NOZZLE	TYPE AND DESCRIPTION	SAMPLE ORDER CODE	TYPE	SIZE RANGE, MATERIAL	\$ (EX. GST)	\$ (INC. GST)	PROD. CAT.
	Disc and Core Jets: • Full and hollow cone spray patterns • Medium to fine droplets for use in air assisted situations • 5–20 bar recommended range	AZ-AD*	Disc	• 1 to 7 • Pink ceramic	7.00	7.70	C
		AZ-AC**	Core	• 13 to 56 • Pink ceramic	12.00	13.20	C

DISC AND CORE ALBUZ CERAMIC - FLOW RATES

DISC SIZE	CORE SIZE	ORIFICES DIAMETER	L/MIN							ANGLES	
			3 BAR	4 BAR	5 BAR	6 BAR	10 BAR	15 BAR	20 BAR	10 BAR	20 BAR
AD 1	AC 3	0,8	0,24	0,27	0,3	0,33	0,41	0,49	0,56	70°	79°
AD 2	AC 13	1,02	0,31	0,35	0,39	0,42	0,53	0,64	0,73	87°	97°
AD 3	AC 13	1,2	0,36	0,41	0,45	0,49	0,61	0,74	0,84	89°	98°
AD 4	AC 13	1,56	0,45	0,52	0,57	0,62	0,78	0,93	1,06	99°	103°
AD 5	AC 13	2	0,55	0,62	0,69	0,75	0,94	1,13	1,29	102°	105°
AD 1	AC 23	0,8	0,28	0,32	0,35	0,38	0,48	0,57	0,65	66°	74°
AD 2	AC 23	1,02	0,37	0,43	0,47	0,51	0,64	0,77	0,88	83°	93°
AD 3	AC 23	1,2	0,44	0,51	0,56	0,61	0,76	0,92	1,04	84°	92°
AD 4	AC 23	1,56	0,56	0,64	0,71	0,77	0,97	1,16	1,32	92°	98°
AD 5	AC 23	2	0,72	0,82	0,91	0,99	1,24	1,49	1,7	96°	99°
AD 6	AC 23	2,4	0,85	0,97	1,07	1,16	1,46	1,75	2	99°	101°
AD 1	AC 25	0,8	0,41	0,46	0,51	0,55	0,7	0,84	0,95	50°	60°
AD 2	AC 25	1,02	0,59	0,67	0,74	0,8	1,01	1,21	1,38	57°	66°
AD 3	AC 25	1,2	0,72	0,81	0,9	0,98	1,23	1,48	1,68	63°	69°
AD 4	AC 25	1,56	1,02	1,16	1,28	1,39	1,75	2,1	2,39	75°	80°
AD 5	AC 25	2	1,41	1,6	1,77	1,92	2,42	2,9	3,3	77°	80°
AD 6	AC 25	2,4	1,73	1,97	2,18	2,37	2,98	3,57	4,07	82°	85°
AD 7	AC 25	2,8	2,07	2,36	2,61	2,83	3,57	4,28	4,87	88°	91°
AD 1	AC 45	0,8	0,48	0,55	0,61	0,66	0,83	1	1,14	32°	39°
AD 2	AC 45	1,02	0,73	0,83	0,92	1	1,26	1,51	1,72	46°	53°
AD 3	AC 45	1,2	0,92	1,05	1,16	1,26	1,58	1,9	2,16	48°	52°
AD 4	AC 45	1,56	1,35	1,54	1,7	1,85	2,32	2,79	3,17	59°	60°
AD 5	AC 45	2	1,92	2,19	2,42	2,63	3,31	3,97	4,52	68°	70°
AD 6	AC 45	2,4	2,46	2,79	3,09	3,35	4,22	5,07	5,77	72°	75°
AD 7	AC 45	2,8	3,01	3,43	3,79	4,11	5,18	6,21	7,07	79°	80°
AD 1	AC 46	0,8	0,55	0,62	0,69	0,75	0,94	1,13	1,29	23°	27°
AD 2	AC 46	1,02	0,92	1,05	1,16	1,26	1,58	1,9	2,16	26°	30°
AD 3	AC 46	1,2	1,2	1,37	1,51	1,64	2,06	2,48	2,82	30°	30°
AD 4	AC 46	1,56	2,03	2,32	2,56	2,78	3,5	4,2	4,78	35°	35°
AD 5	AC 46	2	3,11	3,54	3,91	4,24	5,34	6,41	7,3	40°	42°
AD 6	AC 46	2,4	4,12	4,69	5,18	5,62	7,08	8,49	9,67	45°	46°
AD 7	AC 46	3,230	5,49	6,40	7,10	7,84	10,16	12,43	14,33	55°	53°
AD 1	AC 31	0,8	0,53	0,61	0,67	0,73	0,92	1,1	1,25	39°	39°
AD 2	AC 31	1,02	0,82	0,93	1,03	1,12	1,41	1,69	1,92	87°	95°
AD 3	AC 31	1,2	0,87	0,99	1,1	1,19	1,5	1,8	2,05	65°	62°
AD 1	AC 35	0,8	0,53	0,61	0,67	0,73	0,92	1,1	1,25	34°	40°
AD 2	AC 35	1,02	0,92	1,05	1,16	1,26	1,58	1,9	2,16	39°	39°
AD 3	AC 35	1,2	1,28	1,46	1,61	1,75	2,2	2,64	3	44°	42°
AD 4	AC 35	1,56	2,08	2,37	2,62	2,84	3,58	4,3	4,89	77°	72°
AD 5	AC 35	2	2,62	2,98	3,3	3,58	4,51	5,41	6,16	37°	34°
AD 2	AC 56	1,02	0,88	1	1,11	1,2	1,52	1,82	2,07	21°	20°
AD 3	AC 56	1,2	1,19	1,36	1,5	1,63	2,05	2,46	2,8	28°	32°
AD 4	AC 56	1,56	2,05	2,33	2,58	2,8	3,52	4,23	4,81	35°	38°
AD 5	AC 56	2	3,46	3,94	4,36	4,73	5,96	7,15	8,14	43°	40°
AD 6	AC 56	2,1	5,11	5,82	6,43	6,98	8,78	10,54	12	56°	49°
AD 7	AC 56	2,3	6,87	7,81	8,64	9,38	11,8	14,17	16,12	68°	64°

HOLLOW CONE

FULL CONE

TERMS & CONDITIONS OF SALE

Croplands Equipment Pty Ltd (ACN 006 450 184) and its subsidiaries ("Croplands") hereby agrees with you that, unless expressly amended in writing by Croplands, these Terms comprise the only terms for the supply and sale of goods by Croplands to you and supersede all other terms, conditions or agreements between us and without further notice, will apply to all future transactions between Croplands and you. These Terms override anything that may be implied or expressed on your orders or your own documentation. In these Terms, "goods" means all agricultural products, machinery or services supplied to you by Croplands; "you" means Croplands' customer. If you are more than one, these Terms bind each of you jointly and severally.

1. QUOTES

- A quote by Croplands is an invitation to you to do business with Croplands, it is not an offer. A quote will remain valid for seven (7) business days from the date of the quote, after which time it may be altered or withdrawn without any notice to you.
- Any alteration to a quote will be effective only if it is in writing and altered by Croplands.

2. ACCEPTANCE

Your order(s) will be accepted by Croplands either when Croplands communicates its acceptance to you, or when Croplands takes steps to fill your order, irrespective of whether those steps are communicated to you. Croplands' acceptance of monies, however paid to it, will not constitute an acceptance of your order. Croplands may, in its sole discretions, without any liability to you, cancel any accepted order at any time.

3. WARRANTIES

- Any provisions or rights under the Competition and Consumer Act 2010 or relevant state legislation which cannot be excluded by those statutes or by law are not intended to be excluded by these Terms. All warranties guarantees and conditions, other than those expressly stated in these Terms and whether implied by statute, common law, custom or otherwise are to the extent that the law permits, expressly excluded. If you have acquired goods as a Consumer, these conditions of sale shall not exclude, limit, restrict or modify the rights, entitlements and remedies conferred upon you or the liabilities imposed upon you, by any condition or warranty implied, by the commonwealth, state or territory act or ordinance, rendering void or prohibiting such exclusion, limitation, restriction or modification. Our goods come with guarantees that cannot be excluded under the Australian Consumer Law. You are entitled to replacement or refund for a major failure and for compensation for any other reasonably foreseeable loss or damage. You are also entitled to have the goods repaired or replaced if the goods fail to be of acceptable quality and the failure does not amount to a major failure.
- You accept all risk and responsibility for consequences arising from the use of the goods whether singly or in combination with other products.
- Any liability incurred by us to you is limited to the replacement or repair of the goods or (at our option) refund of the price paid by you, for a period of 12 months from the date of sale, provided the goods have not been damaged through misuse or handling and in particular does not extend to consequential loss.
- To make a claim under this warranty, you can contact us on sales@croplands.com.au, or call 1800-999-162, or contact their local Croplands Representative listed on the www.croplands.com.au/pages/contact.html website. The Buyer should specify the full particulars of such claim and wherever possible return a sufficient part of the goods to enable a proper examination by the Seller.
- Any advice, recommendation, information, assistance or service provided by Croplands in relation to the goods or their use or application is given in good faith, is believed by Croplands to be reliable, but is provided with an express disclaimer for any liability or responsibility on the part of Croplands.

4. PRICES

- All prices unless otherwise stated are expressed in Australian currency and exclude the costs of delivery.
- Notwithstanding any price contained in your order form or other document submitted by you, the price(s) charged to you, subject to clause 1, shall be the price(s) ruling as at the date of delivery. Any price indications or price lists are subject to alteration by Croplands from time to time to reflect price(s) ruling as at the date of delivery.
- If any statutory charge, duty, impost or tax (including GST) ("charge") is levied in respect of the goods and that charge has not been allowed for by Croplands in calculating the price or when raising an invoice, then you must pay that charge and the price for the goods will increase accordingly.
- Croplands may ask you to pay the whole or any part of the price for the goods at any time prior to delivery, as Croplands considers appropriate.
- Croplands may change the price for the goods at any time.

5. DELIVERY OF THE GOODS

- You must pay all costs of freight, delivery and unloading the goods and you must reimburse Croplands for all costs, which it incurs on your behalf in this regard.
- You will pay any additional charges incurred by Croplands if you direct it to deliver the goods at times or to addresses different from those specified in your order as accepted by Croplands.
- You will accept delivery of the goods when they are delivered to the address on your order.
- If you fail to accept delivery of the goods, Croplands may deliver them to a place of storage nominated by you or, failing such nomination, to a place determined by Croplands. Delivery in this way will be deemed to be delivery of the goods to you. You be liable for all costs incurred by Croplands for storage, detention, double cartage or similar causes if these costs are caused by your inability or failure to accept the goods upon delivery.

6. RISK AND INSURANCE

- You assume all risk in the goods (including consigned goods) upon delivery, even if you have not signed a receipt for the goods.
- You must insure the goods so that your insurance is effective immediately upon receipt of delivery of the goods.

7. DELAYS

Whilst Croplands will make reasonable efforts to deliver the goods to you by your requested delivery date(s), it will be under no liability whatsoever if delivery is not made on the date(s) requested. You agree that your requested delivery date is an estimate only. Croplands shall not be liable for any delayed or non-delivery of goods.

8. FORCE MAJEURE

- If Croplands is unable to deliver the goods because of any acts of god, wars, insurrection or other significant internal disturbance, fire, floods, accidents, breakdowns of plant or machinery, unavailability of or delays in shipping, transport strikes, lock-outs of workers, shortages or other default by suppliers of fuel, power or raw material, priority for supplies claimed by the Federal or State Governments of the Commonwealth of Australia or any overseas government, or any other similar happening or event ("force majeure"), then:
 - you will not be entitled to make any claim against Croplands for any delay in the manufacture or delivery of the goods ordered;
 - whilst the delay continues, after 90 days of delay, Croplands and you will each have the option to cancel any orders.
 - Subject to Clause 8(a), you may not cancel any order or any part of it for any other reason without Croplands' prior consent in writing.
 - Croplands may consent to your proposed cancellation of any order or any part of it if you pay to Croplands what it considers to be a fair and reasonable amount to fully compensate it for any costs, expenses, loss of profit and consequential damage that it may have incurred or may suffer because of the cancellation.
- ## 9. PAYMENT
- Subject always to clause 9(c) herein, all goods you order from Croplands will be paid for within 20 days of the last day of the month in which the goods are invoiced. Time for such payment will be the essence of these Terms.
 - You must pay for the goods invoiced when the invoice is due for payment, even if you have not received all of the goods on that invoice.
 - Croplands' express or implied approval of a credit facility in your favour may be revoked at any time, without any reason being given.
 - If you become an insolvent pursuant to any of the provisions of the Corporations Act 2001 or the Bankruptcy Act 1966 or similar law or statute, all amounts then owing by you to Croplands, whether or not those amounts are then due under clause 9(a), will immediately become due and payable.
 - If you fail to pay any amounts due as required, then:
 - In addition to the invoiced amounts, and without prejudice to any of Croplands' other rights and remedies :-
 - You must pay interest on all amounts due and payable to Croplands at the rate equal to the target cash rate of the Reserve Bank of Australia plus 5% at the time the relevant amounts fall due, calculated from the date that each amount you owe Croplands becomes due and payable; interest will continue to accrue until all the monies you owe are received in cleared funds by Croplands.
 - You must indemnify Croplands for all loss and damage it incurs because of your failure to pay all amounts due to it by the due date(s);
 - You must indemnify Croplands for all costs, loss and damage it incurs in taking possession of the whole or part of the goods and reselling them or by any other reason, if that loss and damage is the result of your conduct;
 - You must pay interest on all loss and damage suffered by Croplands at the rate set out in sub-clause 9(e)(i)(A) as a result of your conduct or your breach of these Terms;
 - You must pay all costs, charges and expenses ("costs") incurred by Croplands in enforcing or attempting to enforce any of its rights under these Terms (including recovering any loss and damage or unpaid amounts). In the case of legal costs, you will pay Croplands' legal costs on an indemnity basis; and
 - You must deliver up the goods to Croplands immediately upon receipt of a demand in writing from Croplands to this effect. If you do not comply with the demand within one (1) business day of receipt of the demand, you authorise Croplands to enter upon your premises (whether owned or leased) at any time to do all things necessary to take possession of the goods. You must pay all costs of and incidental to Croplands' exercise of its rights under this clause on the basis set out in clause 9(e)(i)(E).
 - You authorise Croplands to apply any payments received from you first to satisfy interest which may have accrued on the amounts you owe it, next to any legal or other costs Croplands may have incurred in recovering the amount(s) from you, and then only to the principal amount.
 - If you are involved in any dispute with Croplands, you must still pay all amounts due to Croplands. You must not withhold payment, set off or "contra" any amounts that you owe Croplands because of any claims that you may have, whether on account of your supply of goods, to Croplands, damages or other allegation against Croplands.
- ## 10. RETENTION OF TITLE
- Subject to clause 10(b), and unless otherwise notified in writing, you are authorised to sell or use the goods if it is in the ordinary course of your business to do so.
 - Until full payment in cleared funds is received by Croplands for all goods sold by it to you, and any other amounts owing to Croplands are paid title and property in the goods will remain vested in Croplands and will not pass to you;
 - you must hold the goods as fiduciary bailee and agent for Croplands; and
 - you must keep all goods supplied and delivered to you by Croplands separate from your and other property, and in a manner to enable Croplands' goods to be identified.
 - If you sell, dispose of or use the goods before full payment in cleared funds is made to Croplands, until such full payment is made, you will hold all monies resulting from such sale, disposal or use on trust for Croplands in a separate account. You must not mix the monies you hold on trust for Croplands with your or any other monies and you must specifically identify relevant trust monies in your accounts as Croplands' property.
 - If you combine or incorporate the goods with other goods (not being the property of Croplands) before full payment in cleared funds is made to Croplands, so that Croplands' goods become mixed with goods of others, you authorise Croplands to dismantle and remove its goods from the other goods, if such dismantling or removal is possible without destroying the goods, yours or others' goods.
 - If you combine the proceeds of sale of the goods with other money in your bank account before you pay Croplands for the goods, you must expressly hold those proceeds on trust for Croplands and you hereby authorise Croplands to trace and receive those proceeds ahead of all other creditors, including secured creditors.
 - Croplands shall have a lien on any of your goods if you owe it money for goods sold and delivered to you, or if you owe it money for any loss and damage that you have caused to Croplands.

11. ASSIGNMENT OF DEBT

- (a) In consideration of Croplands' agreement to supply the goods to you on these Terms, and Croplands' undertaking to reimburse to you all of your profit in respect of the goods or any end product manufactured or cultivated with the goods ("end product"), you hereby assign to Croplands the whole of proceeds of the sale of the goods or end product to your customers, including any insurance proceeds payable to you in respect of your insurance of the goods or end product, immediately that the goods or any end product are either sold to your customers, or damaged or destroyed, whichever appropriate ("the assigned debt").
- (b) The assignment to Croplands in clause 11(a) above will be effected simultaneously with and automatically upon the sale of the goods, or any end product, to your customers.
- (c) Notwithstanding the assigned debt, Croplands will always be entitled to sue you for the price of the goods if you do not pay for them when payment is due.
- (d) If any part of the assigned debt is paid to or received by you, you acknowledge and declare that you receive and hold the assigned debt upon trust for Croplands, that you will not deal with or treat that receipt as part of your own money and will forthwith pay it to Croplands. Croplands will have the right to trace the assigned debt you receive from your customers to your bank account, even if those monies become mixed with other monies in your account.
- (e) You promise that you will execute any documents, do any acts or other things that Croplands may reasonably require you to do to further or more perfectly transfer the assigned debt to Croplands.
- (f) You will deliver possession and control of any documentation relating to or proving the assigned debt to Croplands upon Croplands' request, and Croplands jointly with you will be responsible for the management and collection of the assigned debt from that time on.
- (g) You promise that immediately upon effecting each and every sale of the goods or end product to your customers, you will (at Croplands' request) do all things necessary to inform your customers of the form and substance of this assignment, and further, do all things necessary to enable Croplands to collect the assigned debt from your customers.

12. PERSONAL PROPERTIES SECURITY ACT 2009 (PPSA)

- (a) In this clause 12, unless otherwise defined in these Terms, capitalised expressions have the meaning given to them in the PPSA.
- (b) You acknowledge and agree that by entering into a contract of sale under these Terms, you grant a Security Interest to Croplands in the goods and any proceeds of sale in respect to those goods and also consent to Croplands registering any one or more Financing Statements or Financing Change Statements in respect to any such Security Interest created by or contemplated by these Terms.
- (c) You and Croplands agree for the purposes of satisfying s20(1)(iii) of the PPSA, that the description of goods as shown on any invoice from Croplands is the subject of each and any Security Interest created under these terms and such and every invoice is incorporated into these Terms.
- (d) You agree that you are the Grantor and Croplands is the holder of a Purchase Money Security Interest (PMSI) by virtue of these Terms or the PPSA.
- (e) You agree that the following provisions of the PPSA will not apply to these Terms: Sections 95, 96, 125, 129, 130, 132(3)(d), 132(4), 135, 142 and 143.
- (f) Unless otherwise agreed in writing with Croplands, you agree to waive your rights to receive a verification statement in accordance with s157 of the PPSA.
- (g) For the purposes of s275(6) of the PPSA, you and Croplands agree that neither party will, or is entitled to, disclose information of the kind specified in s 275(1) of the PPSA.
- (h) You agree with Croplands that it will not enter into any agreement or arrangement which permits any other person to register any Security Interest in respect to unpaid goods, proceeds of sale of unpaid goods or any accounts owed in respect of the unpaid goods without Croplands' consent.
- (i) You agree to give Croplands at least 10 days prior written notice before changing any of your corporate details, such as your name, ABN or ACN, or principle place of business.
- (j) You agree to unconditionally ratify any actions taken by Croplands under this clause 9.
- (k) You agree to reimburse Croplands for all costs and/or expenses incurred or payable by Croplands in relation to registering, maintaining or releasing any Financing Statement or Financing Change Statement under these terms.
- (l) This clause 9 will survive the termination of the contract for sale and purchase of goods between you and Croplands to the extent permitted by law.

13. CLAIMS AND RETURNS

- (a) You must inspect the goods immediately on delivery and must, no later than seven (7) business days of receipt of the goods, give notice in writing to Croplands if the goods are not in accordance with Croplands' specifications for the goods or if the goods are damaged, short supplied or otherwise allegedly defective. If you do not give such notice within 7 days, you must accept and pay for the goods and you are no longer able to make any claim. Time is of the essence in the giving of such notice.
- (b) You may not make a claim against Croplands in respect of the goods unless at the time of the claim all of the goods the subject of the claim remain intact as a whole. Any disposal or use of any part of the goods will mean that you have accepted the goods and can no longer make any claim.
- (c) You grant to Croplands full and free access to the premises owned or occupied by you to enable Croplands to investigate any claim you make. Croplands' investigation of your claim does not constitute an admission of liability.
- (d) Croplands may, in its sole discretion, accept the return of the goods or refund you the purchase price of the goods. The invoice and/or the delivery note number must be supplied with the goods if they are returned.

14. LIMITATION OF LIABILITY AND INDEMNITY

- (a) Any representation made by Croplands in relation to the goods, their use, suitability for your purpose or application is given in good faith, is believed by Croplands to be reliable, but is provided with an express disclaimer for any liability or responsibility on the part of Croplands. You acknowledge that Croplands is not or may not be aware of your intended end use of the goods.
- (b) Subject only to the extent permissible at law, you agree that Croplands will not be liable to you for any consequential loss or damage that you incur or suffer as a direct or indirect result of your purchase, use or application of the goods. You hereby expressly release and discharge Croplands from any and all such consequential loss or damage, however incurred, whether directly or indirectly as a result of:
 - i. your purchase, sale, use or application of the goods;
 - ii. any changes Croplands makes from time to time to the specifications or price of the goods; and
 - iii. any delay or cancellation of your order.

- (c) You accept all risk and responsibility for consequences arising from the improper use of the goods.
- (d) You acknowledge that any liability to you will be limited, in the case of any goods not in accordance with Croplands' specifications or if the goods are damaged, short supplied or otherwise allegedly defective only to:
 - i. replacement by Croplands of the goods; or
 - ii. the issue of a credit note for the invoice value of the goods; or
 - iii. the return of any monies that you have paid in respect of the goods; or
 - iv. the return of the goods;
 whichever Croplands in its absolute discretion considers appropriate.
- (e) You will indemnify Croplands for all and any loss and damage whatsoever or howsoever incurred by it, whether as a direct or indirect result of your failure to observe these Terms, your failure to discharge your duties under the common law or your failure to discharge your duties under statute, or otherwise.

15. PALLETS

- (a) Any pallets used for the delivery of the goods to you remain the sole property of Croplands and are to be returned to Croplands' warehouse at your expense and in good order and condition.
- (b) Any pallets not returned within 14 days after Croplands' demand will, at Croplands' election, be deemed to be purchased by you. In that event, you will be invoiced for the pallets at a value to be determined by Croplands. That value will be final and binding as between the parties.

16. GOODS ON CONSIGNMENT

- (a) If you hold goods on consignment you must maintain accurate records of these goods as required by Croplands and rotate the goods so that the oldest are sold or used first.
- (b) You must provide to Croplands a reconciliation in respect of the goods on consignment immediately following the end of March, June, September and December each year ("reconciliation") advising:
 - I. The opening balance for that quarter, batch numbers for the goods unsold, remaining in your possession and on consignment as at the commencement of the quarter;
 - II. the quantity of goods received from Croplands each quarter including the batch numbers in respect of the goods received;
 - III. the quantity of goods sold in each quarter including the batch numbers in respect of each of the goods sold; and
 - IV. the closing balance for each quarter, batch numbers of the goods unsold, remaining in your possession and on consignment as at the conclusion of each quarter.
- (b) You must notify Croplands as soon as you receive a purchase order from a customer for any of the goods on consignment. Croplands will invoice you each month for the price of the goods as the date(s) of sale to your customers. You must pay for the goods on consignment in accordance with clause 9.
- (c) Croplands will invoice you for any lost or damaged goods on consignment and you must pay for these goods in accordance with clause 9 of the Terms.
- (d) You may only dispose of or use the goods on consignment in accordance with these Terms. All monies resulting from the sale of the goods on consignment will be dealt with in the manner set out in clause 9.

17. MISTAKE

Any mistake of fact on any quote, order, invoice, delivery docket or other document issued by Croplands in relation to the goods will not bind Croplands and Croplands may in its discretion issue such amended document as is required to rectify the mistake. You must comply with Croplands' amended document.

18. YOUR REPRESENTATIONS

You represent that:-

- (a) the goods will only be used and applied in accordance with Croplands' directions and recommendations and in accordance with the registered label;
- (b) the goods will be handled with appropriate caution, care and protective clothing;
- (c) the goods will be used or applied with the appropriate utilities only;
- (d) you are aware that some goods purchased from Croplands may be toxic, dangerous and hazardous to human health;
- (e) the goods the subject of any proposed claim have not continued to be used by you:
 - i. after you have become aware that the goods are damaged or defective in any way; or
 - ii. after you have given written notice of the defects to Croplands;
- (f) you will report any defects to Croplands in accordance with clause 13.

19. ACCESS

You irrevocably grant to Croplands authority to enter into, forcibly or otherwise, all of your owned and leased premises for the purpose of inspecting or removing any of Croplands' goods.

20. DANGEROUS GOODS

You warrant to Croplands that after delivery of the goods and whilst Croplands retains any interest in the goods, you will comply with all applicable Acts, Regulations and Laws dealing with the transport, unloading, storage, sale or use of dangerous or hazardous materials.

21. LAW/INTERPRETATION

- (a) These Terms are to be interpreted according to the laws of the State of Victoria. The courts in the State of Victoria shall have exclusive jurisdiction to hear and determine all disputes of and incidental to these Terms, including any claims in respect of monies due to Croplands pursuant to these Terms, on account of a claim for damages or any other claim.
- (b) To the maximum extent permitted by law and statute, all warranties terms and conditions, expressed or implied by common law, equity, trade, custom, usage, statute or otherwise, in relation to the sale, supply, use or application of the goods, are excluded. Croplands shall not accept any responsibility whatsoever (including consequential loss), or howsoever arising (including negligence) for any damage, injury or death connected with the sale, supply, use or application of the goods except for responsibility for the merchantable quality and except for any responsibility mandatorily imposed by statute.

22. SEVERANCE

If the whole or any part of these Terms is invalid or unenforceable for any reason, the invalid or unenforceable clauses will be severed from these Terms and the validity of the remaining clauses will be preserved.

Updated March 2020.

FREIGHT

The following tables detail freight on items listed in the 2024 Compact Sprayers guide.

- Prices may change at any time without notice. Freight charges will apply unless items are ordered that qualify to be included in a stock order
- Charges apply Australia-wide. Goods can be sent by your choice of carrier and/or arranged for pick-up, or sent freight forward if we are advised at the time of order. Croplands is not responsible for any charges incurred for missed collection or delays when using your own courier service
- All freight prices include any applicable fuel surcharges and remote area surcharges
- Minimum order value is 50 EX GST
- All deliveries will be direct to dealers.

SPARE PARTS, COMPONENTS & ACCESSORIES

- Spare parts
- Regulating valves
- Spray guns
- Boom components
- Tank fittings
- Nozzles and nozzle caps
- Ball valves
- Respirators
- Filters
- Camlocks
- 12V pumps
- Solenoids
- Gloves and suits
- Gauges
- Brass and poly fittings

AIRFREIGHT

Note: cut-off for air freight orders is 2:30pm ACDT.
Bookings after this time will not guarantee next day delivery

ITEM	NOTES	\$(EX. GST)
Parts, accessories, components	1kg bag	24.75
Parts, accessories, components	3kg bag	28.50
Parts, accessories, components	5kg bag	39.00

STOCK ORDERS

Back orders maybe consolidated to reduce freight costs.
Croplands tanks do not qualify for stock orders

ITEM	NOTES	\$(EX. GST)
Parts, accessories, components with a dealer nett value of 3,000.00 + GST*	<ul style="list-style-type: none"> • Mark your order clearly as a 'STOCK ORDER' • Stock orders can take up to five working days to pack and dispatch • Minimum of 15 individual lines must be ordered 	F.I.S.

*All items marked in **BLUE** qualify for stock orders

*All items marked in **ORANGE** do not qualify for stock orders

WHOLEGOODS

Sent by road freight as individual items

ITEM	FREIGHT \$(EX. GST)
LINKAGE SPRAYERS (P4-13)	
LA300 and LA600 – all models up to 6m boom	480
LA800 – bare or with 6m boom	540
LA600/MAX08, LA800/MAX08 with 8m boom	700
LA800/MAX10L with 10m boom	730
LAC1000, LAC1000/80 bare unit (no boom)	830
LAC1000/80/8M, 10M and 12ML models with 8, 10 and 12m booms	1300
LAC1000/MHL12 or MHL15 – 100L with 12/15m hyd fold booms	1400
MEC1300/1600 with boom attached	POA
Cropair 300 and 600L fan sprayers (P18-19)	800
SPRAY BOOMS (P14-17)	
MSO, MSCL, MB02, MBX04 booms	95
MC6, MBX06, MSCL-2, MVB5-5 booms	105
MAX08 – flat pack only	200
MAX10 – flat pack only	200
MAX10L, MAX12L and GEX series booms – flat pack only	260
MHL 12 and 15m booms; BDU18 boom only – flat pack only	POA
TRAILPAK SPRAYERS (P21-23)	
UA300B trailing sprayer (all models) and UA300B motorised nursery sprayers	740
1100 and 1500L TrailPak sprayers	POA
RETRASPRAY & TRAYPAK SPRAYERS (P24-27)	
RSRL3-100RC RetraSpray reel	230
US20F/25, US20F/252 and US30F/30 complete units	400
US500/30/HR30TG, US500/40/TWIN traymount units	600
US60F complete units	540
CROPPAK 12V SPRAYERS, KNAPSACK SPRAYERS & APEX SPRAYERS (P28-35)	
US30S and AR30 CropPak sprayer	70
US60S, US100S, US100A/15, AR60, AR100, AR100/15, 12V CropPaks	90
US200F and US200F/15 12V CropPaks	190
US300F/15 12V CropPaks	420
Swissmex SW319 and SW320 x 1 unit	45
Swissmex SW319 and SW320 x 10 units	140
SW503, SW189C, ASBBS-16A x 1 unit	50
SW503, SW189C, ASBBS-16A x 10 units	210
PAKMAN back protector, all Swissmex spray booms	50
CHEMICAL MIXING & BATCHING UNITS; MIXING JUGS & CHEMICAL TRANSFER UNITS (P36-38)	
L-H9351A 60L mixer	155
L-H9351A with L-H9355A dropdown bracket	175
L-H9353A, L-9353C 60L mixers with trolley	200
L-H9003 and 9005 measuring jugs, 10 each	60
L-H9003 and 9005 measuring jugs, up to 5 each	50
L-H9025 25L buckets (each)	50
L-H9025 25L buckets (x 3)	60
SHUSF-1105PTSI AgRunner transfer unit	55
BOOMLESS NOZZLE KITS, FOAM, FOAM MARKERS (P17, 41)	
Boomless nozzle kits	25
Foam markers	85
Spray tanks	POA
HOSE REELS, HOSE, SPRAY GUNS (P34-35)	
30m rolls spray hose	45
All hose reels and 100m rolls hose	70
All spray guns x 1	30
All spray guns x 10	65
FIREFIGHTERS (P40)	
500L TrayPak firefighter	600
Trailed firefighters 1100/1500L models	POA
SPRAY PUMPS (P43)	
AR pumps with gearboxes – models AR303, AR30, AR503, AR813	85
AR pump models AR30, AR70, AR252, AR503	50
AR pump models AR140, AR160, AR185 & 250, ARBHS170, ARBHS200	105
Hypro centrifugal pumps	70
FloJet and SHURflo 12V pumps x 1 unit	30
FloJet and SHURflo 12V pumps x 12 unit	80
RESPIRATORS, SPRAY MANIFOLDS, SPRAY CONTROLLER KITS & GPS UNITS (P53-56)	
Kasco respirators	40
All control manifolds and I-E2021, 2032, 2052, I-E4020, 4021	85
All controller kits and GPS units (BA5000-GE03 etc)	70

NOTES

Utilise this space to detail items you are interested in, would like to enquire about, or place an order for.

PERSONAL DETAILS

NAME	
CUSTOMER #	
DEALER NAME / PHONE #	
DELIVERY ADDRESS	
DELIVERY CONTACT NAME / PHONE #	

ITEM DETAILS

PAGE #	ITEM CODE	NOTES	RRP (\$)	PROD.CAT.	FREIGHT \$ (EX. GST)	NOTES

